

23MT2336/17



Thank you for choosing Magnavox.

Need help fast?

*Read your Quick Use Guide and/or
Owner's Manual first for quick tips
that make using your Magnavox product
more enjoyable.*

*If you have read your instructions
and still need assistance,
you may access our online help at
www.usasupport.magnavox.com*

or call

1-800-705-2000

*while with your product
(and Model / Serial number)*

Model No : _____

Serial No : _____

Return your Product Registration Card today to get the very most from your purchase.

Registering your model with MAGNAVOX makes you eligible for all of the valuable benefits listed below, so don't miss out. Complete and return your Product Registration Card at once to ensure:

*Proof of Purchase

Returning the enclosed card guarantees that your date of purchase will be on file, so no additional paperwork will be required from you to obtain warranty service.

*Product Safety Notification

By registering your product, you'll receive notification - directly from the manufacturer - in the rare case of a product recall or safety defect.

*Additional Benefits of Product Ownership

Registering your product guarantees that you'll receive all of the privileges to which you're entitled, including special money-saving offers.

MAGNAVOX

*Congratulations on your purchase,
and welcome to the "family!"*

Dear MAGNAVOX product owner:

Thank you for your confidence in MAGNAVOX. You've selected one of the best-built, best-backed products available today. We'll do everything in our power to keep you happy with your purchase for many years to come.

As a member of the MAGNAVOX "family," you're entitled to protection by one of the most comprehensive warranties and outstanding service networks in the industry. What's more, your purchase guarantees you'll receive all the information and special offers for which you qualify, plus easy access to accessories from our convenient home shopping network.

Most importantly, you can count on our uncompromising commitment to your total satisfaction.

All of this is our way of saying welcome - and thanks for investing in a MAGNAVOX product.

P.S. To get the most from your MAGNAVOX purchase, be sure to complete and return your Product Registration Card at once.

Know these
safety symbols



This "bolt of lightning" indicates uninsulated material within your unit may cause an electrical shock. For the safety of everyone in your household, please do not remove product covering.

The "exclamation point" calls attention to features for which you should read the enclosed literature closely to prevent operating and maintenance problems.

WARNING: To reduce the risk of fire or electric shock, this apparatus should not be exposed to rain or moisture and objects filled with liquids, such as vases, should not be placed on this apparatus.

CAUTION: To prevent electric shock, match wide blade of plug to wide slot, fully insert.

ATTENTION: Pour éviter les choc électriques, introduire la lame la plus large de la fiche dans la borne correspondante de la prise et pousser jusqu'au fond.

For Customer Use

Enter below the Serial No. which is located on the rear of the cabinet. Retain this information for future reference.

Model No. _____

Serial No. _____

MAGNAVOX

Visit our World Wide Web Site at <http://www.usasupport.magnavox.com>

IMPORTANT SAFETY INSTRUCTIONS

Read before operating equipment

1. Read these instructions.
2. Keep these instructions.
3. Heed all warnings.
4. Follow all instructions.
5. Do not use this apparatus near water.
6. Clean only with a dry cloth.
7. Do not block any of the ventilation openings. Install in accordance with the manufacturer's instructions.
8. Do not install near any heat sources such as radiators, heat registers, stoves, or other apparatus (including amplifiers) that produce heat.
9. Do not defeat the safety purpose of the polarized or grounding-type plug. A polarized plug has two blades with one wider than the other. A grounding type plug has two blades and a third grounding prong. The wide blade or third prong are provided for your safety. When the provided plug does not fit into your outlet, consult an electrician for replacement of the obsolete outlet.
10. Protect the power cord from being walked on or pinched, particularly at plugs, convenience receptacles, and the point where they exit from the apparatus.
11. Only use attachments/accessories specified by the manufacturer.
12. Use only with a cart, stand, tripod, bracket, or table specified by the manufacturer or sold with the apparatus. When a cart is used, use caution when moving the cart/apparatus combination to avoid injury from tip-over.
13. Unplug this apparatus during lightning storms or when unused for long periods of time.
14. Refer all servicing to qualified service personnel. Servicing is required when the apparatus has been damaged in any way, such as if the power-supply cord or plug is damaged, liquid has been spilled or objects have fallen into the apparatus, or if the apparatus has been exposed to rain or moisture, does not operate normally, or has been dropped.
15. This product may contain lead and mercury. Disposal of these materials may be regulated due to environmental considerations. For disposal or recycling information, please contact your local authorities or the Electronic Industries Alliance (www.eiae.org).
16. **Damage Requiring Service** - The appliance should be serviced by qualified service personnel when:
 - A. The power supply cord or the plug has been damaged;



- B. Objects have fallen or liquid has been spilled into the appliance;
 - C. The appliance has been exposed to rain;
 - D. The appliance does not appear to operate normally or exhibits a marked change in performance;
 - E. The appliance has been dropped or the enclosure damaged.
17. **Tilt/Stability** - All televisions must comply with recommended international global safety standards for tilt and stability properties of its cabinet design.
- Do not compromise these design standards by applying excessive pull force to the front, or top, of the cabinet, which could ultimately overturn the product.
 - Also, do not endanger yourself, or children, by placing electronic equipment/toys on the top of the cabinet. Such items could unsuspectingly fall from the top of the set and cause product damage and/or personal injury.
18. **Wall or Ceiling Mounting** - The appliance should be mounted to a wall or ceiling only as recommended by the manufacturer.
19. **Power Lines** - An outdoor antenna should be located away from power lines.
20. **Outdoor Antenna Grounding** - If an outside antenna is connected to the receiver, be sure the antenna system is grounded so as to provide some protection against voltage surges and built up static charges. Section 810 of the National Electrical Code, ANSI/NFPA No. 70-1984, provides information with respect to proper grounding of the mast and supporting structure, grounding of the lead-in wire to an antenna discharge unit, size of grounding connectors, location of antenna-discharge unit, connection to grounding electrodes, and requirements for the grounding electrode. See Figure below.
21. **Object and Liquid Entry** - Care should be taken so that objects do not fall and liquids are not spilled into the enclosure through openings.
22. **Battery usage CAUTION** - To prevent battery leakage that may result in bodily injury, property damage, or damage to the unit:
- Install all batteries correctly, with + and - aligned as marked on the unit.
 - Do not mix batteries (old and new or carbon and alkaline, etc.).
 - Remove batteries when the unit is not used for a long time.
23. Apparatus shall not be exposed to dripping or splashing and no objects filled with liquids, such as vases, shall be placed on the apparatus.

Note to the Cable TV system installer: This reminder is provided to call the Cable TV system installer's attention to Article 820-40 of the NEC that provides guidelines for proper grounding and, in particular, specifies that the cable ground shall be connected to the grounding system of the building, as close to the point of cable entry as practical.

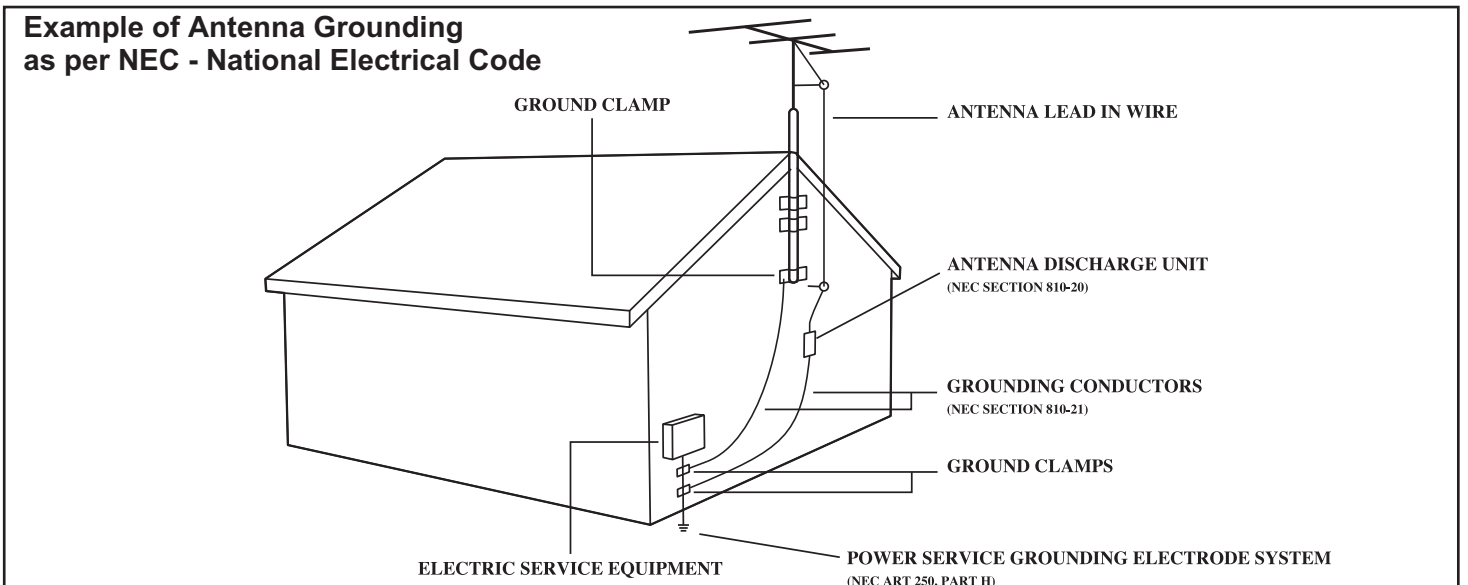

Table of Contents

Introduction

Welcome/TV Registration	2
Safety/precaution	3
Table of Contents	4
Features	4

Getting Started

Basic Cable TV connection	5
Basic Antenna Connection	6
Basic TV to VCR (Accessory) Connection	7
Basic TV and Remote Control Operations	8
Remote Control	9



Setup Menus

Language	10
TV/Cable TV	11
Auto Search (Setting TV Channels)	12
Manual Channel Tuning	13
Favorite Channel Setting	14
Adding or Erasing Channels	15



On-screen Menus

Picture Adjustments	16
SmartPicture™	17
Clock	18
On-Timer	19
Off-Timer	20
Closed Caption	21
Sleep Timer	22



Parental Lock

Understanding Parental Lock	23
Parental Lock Secret Code	24
Blocking Programming with Movie Ratings	25
Blocking Programming with TV Ratings	26
Parental Lock Blocking Options	27
Child Lock	28

Sound

SmartSound™	29
Sound Adjustments	30
Stereo and Second Audio Program	31



General Information

Helpful Hints	32
Care and Cleaning	32
Glossary	33
Index	33
Limited Warranty	34

SmartPicture and SmartSound are trademarks of Magnavox North America. Copyright 2004 Magnavox

Features

Automatic Channel Programming: Quick and easy selection of available stations.

Child Lock: Locks the buttons on the front of the TV so it cannot be operated accidentally by young children.

Closed Captioning: Allows you to read TV program dialog or voice conversations as on-screen text.

Off-Timer: Turns off the TV at a preset time.

On-Timer: Turns on the TV at a preset time to a designated TV channel or video source.

On-screen Menus: Helpful message (in English or French or Spanish) for setting TV controls.

Parental Lock: Allows you to block the viewing of certain TV channels if you do not want your children viewing inappropriate material.

Remote Control: Works your TV features.

Sleep Timer: Turns off the TV within an amount of time you specify. (15-180 minutes from the current time).

SmartPicture: Lets you set the picture's color, tint, contrast, etc. for various types of programming. Settings include Sports, Movies, Weak Signal, and Personal, which set the picture control as you want.

SmartSound: Lets you set the TV's sound settings for the current programming. Choices include Personal, Theatre, Music, or Voice.

Standard broadcast (VHF/UHF) or Cable TV channel capability.

Stereo Capability: Includes built-in amplifier and twin-speaker system; allows reception of TV programs broadcast in stereo.



As an Energy Star® Partner, Magnavox has determined this product meets the Energy Star® guidelines for energy efficiency. Energy Star® is a U.S. registered mark. Using products with the Energy Star® label can save energy. Saving energy reduces air pollution and lowers utility bills.

Basic Cable TV Connection



The cable TV signal into your home may be a single cable (75ohm) or may include a cable Box. In either case, the connection to the TV is easy.

If your Cable TV signal comes directly via a 75 ohm coaxial cable, use the following steps:

- 1 Connect the Cable TV signal to the 75 OHM ANTENNA INPUT jack on the rear of the TV.** Screw it down finger tight.
- 2 Plug the TV's power cord into a power outlet and turn on the TV.** Set TV/CATV to CATV as detailed in page 11. Refer to **AUTO SEARCH** to set up your available channels. Details are on page 12.

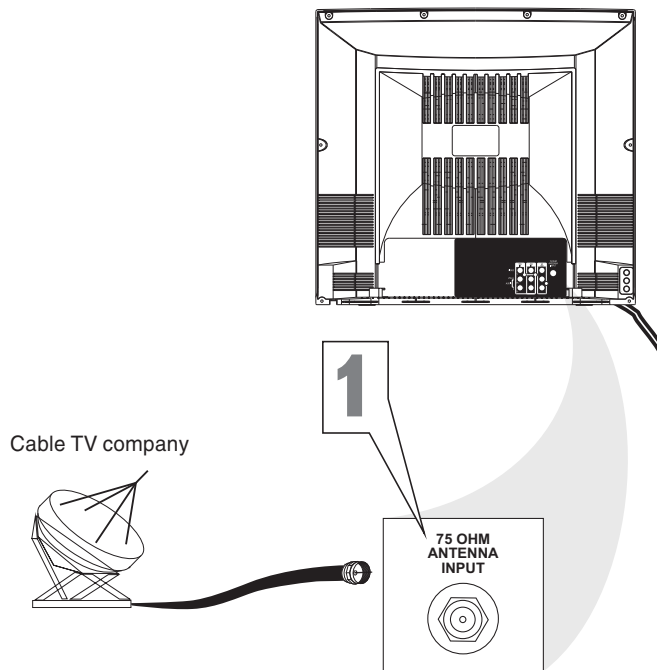

If you have a Cable Box, use the following steps.

- 1 Connect the Cable TV signal to the IN jack on the Cable Box.**
- 2 Connect the separate coaxial cable to the OUT jack on the Cable Box and to the 75 OHM ANTENNA INPUT jack on the rear of the TV.**
- 3 Plug the TV's power cord into a power outlet and turn on the TV.** Set TV/CATV to CATV as detailed in page 11.
- 4 Set the TV to channel 3 or 4** (the same as the Channel3/4 switch on your Cable Box if applicable). **Change channels at the Cable Box.**

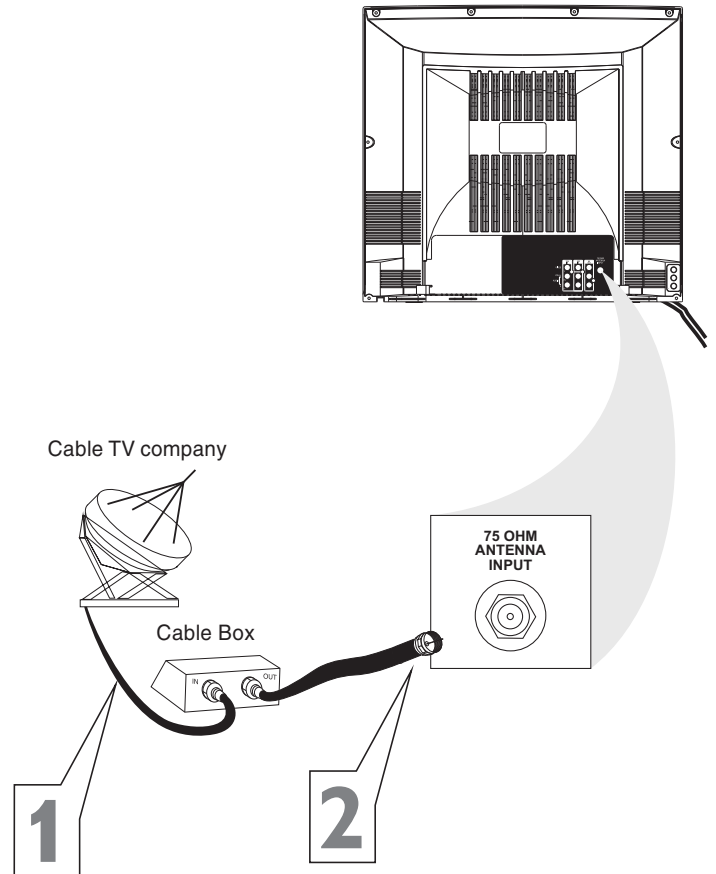

Helpful Hints

An RF coaxial cable (to connect the Cable Box to the TV) may be supplied by the Cable TV company. It is not supplied with the TV but it is available from Magnavox or electronics retailers. You can connect a Satellite Receiver the same way you would connect a Cable Box.

Your Cable Box may have separate Audio and Video Out jacks instead. If so, use audio and video cables to connect the AUDIO /VIDEO OUT jacks of the Cable Box to the AUDIO/VIDEO IN2 jacks on the rear of the TV. Press the TV/AV on the remote control to set the TV to the AV2 channel. Change channel at the Cable Box.



Basic Antenna Connection

A combination antenna receives normal broadcasting channels (VHF2-13 and UHF 14-69). Your connection is easy since you will connect the antenna to the 75OHM ANTENNA INPUT jack on the rear of the TV.

- 1** If your antenna has a round cable (75 ohm) on the end, then you are ready to connect it to the TV. Go to step 2.
- If your antenna has flat twin-lead wire (300 ohm), you first need to attach the antenna wire to the screws on a 300 to 75 ohm adapter (not supplied with TV).

- 2** Push the round end of the adapter or antenna cable onto the 75 OHM ANTENNA INPUT jack on the rear of the TV. If the round end of the antenna cable is threaded, screw it down finger tight.

- 3** Plug the TV's power cord into a power outlet and turn on the TV. Set TV/CATV to CATV as detailed on page 11. Refer to **AUTO SEARCH** to set up your available channels. Details are on page 12.

Note: this TV has no hand grip, which is a recess at either side of the cabinet for ease of transportation of bigger sets.

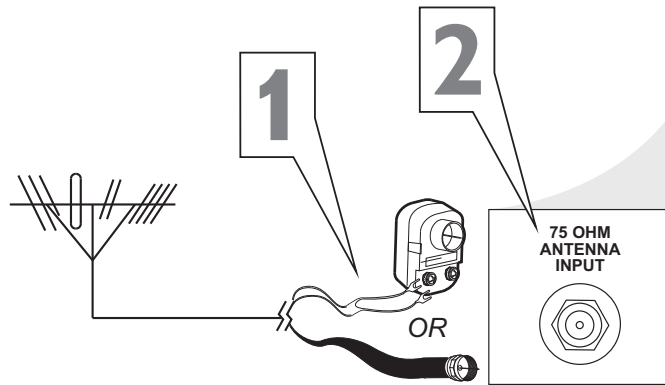
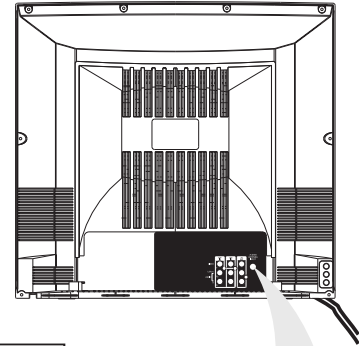

If you have separate UHF and VHF antennas, you need an optional combiner to connect to the TV.

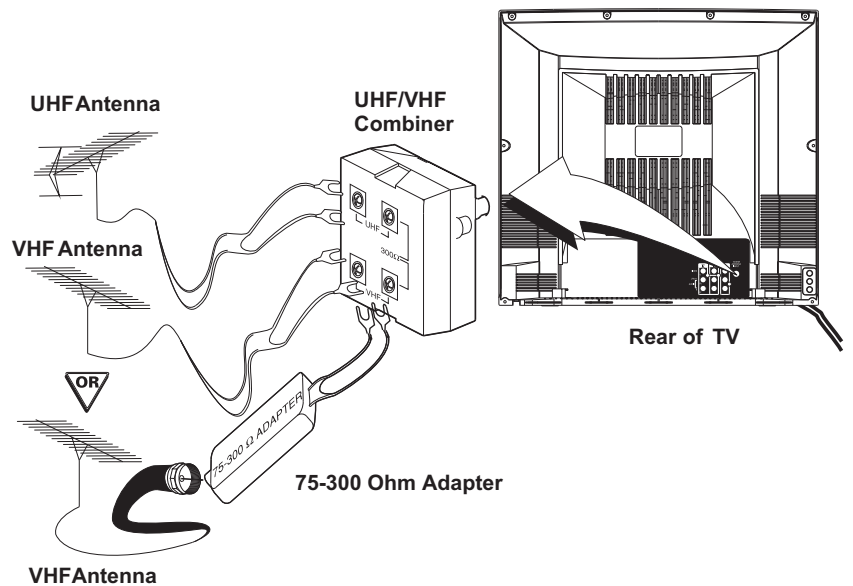

Basic TV to VCR (Accessory) Connection



The basic Antenna/Cable TV to Accessory (VCR, DVD Player, etc.) to TV connection is shown at right. For other hookups (such as those with Cable Boxes), refer to the owner's manual of the Cable Box or other Accessories.

- 1** Connect a yellow video cable to the VIDEO IN2 jack on the rear of the TV and to the VIDEO OUT jack on your VCR (or other Accessories.)
- 2** Connect red and white audio cables to the AUDIO IN2 jacks (left and right) on the rear of the TV and to the AUDIO OUT jacks on your VCR (or other device.) Match the cable colors to the jack colors.
- 3** Turn on the TV and the VCR.
- 4** Press the TV/AV button on the TV's remote control until AV2 appears in the upper right corner of the TV screen. When you play material on the VCR, DVD player, etc. that is connected to the AUDIO and VIDEO IN2 jacks on the rear of the TV, it will appear on the TV on the AV2 channel.

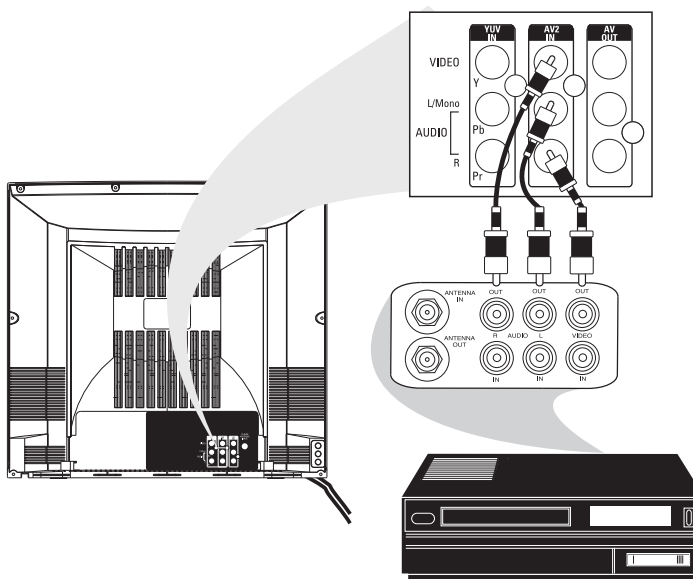

Helpful Hints

Audio and video cables are not supplied with the TV but are available from Magnavox or electronics retailers. Audio cables are usually red and white. Video cables (CVBS) are usually yellow. You can connect the antenna or Cable TV signal to either the ANTENNA IN jack on your VCR or to the 75 OHM ANTENNA INPUT jack on the TV. If you connect it to the VCR, choose TV channels at the VCR. Connect it to the VCR if you want to record TV programming through VCR. Your VCR may not have Audio and Video Out jacks, but only An RF or ANTENNA OUT jack. Use a coaxial cable to connect the VCR's ANTENNA OUT jack to the TV's 75 OHM ANTENNA INPUT jack.

There are Component Video In jacks on the rear of the TV. These are labeled DVD INPUT Y, Cb and Cr and are red, blue and green. Use these to connect a DVD player that has Component Video Out jacks. This will provide the best picture quality. Use Component Video cables, which are not supplied with the TV. If you connect the DVD player to the DVD jacks, set the TV to YUV channel to watch DVDs. Press TV/AV button on the remote so YUV appears on the TV screen. Use either DVD or VIDEO In2 jacks, but do not use both for the same piece of equipment. You only need one video connection per each accessory (DVD player, etc.).

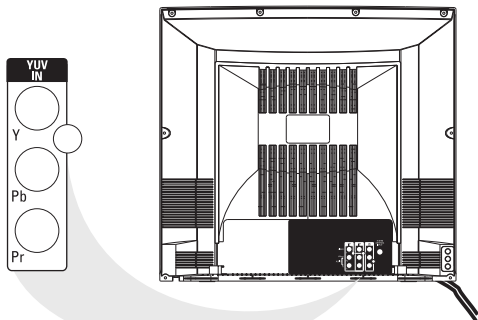

There are AUDIO and VIDEO IN1 jacks at the lower-right corner of the rear of the TV set. To view material playing on equipment connected here, press the TV/AV so AV1 is shown on the TV.

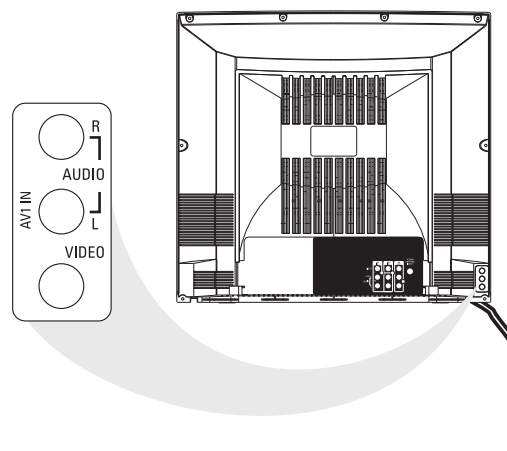



Basic TV and Remote Control Operations

Television

- 1 Press POWER** to turn on the TV.
- 2 Press VOL. ▲** to increase the sound level. Press VOL. ▼ to lower the sound level.
- 3 Press CH. ▼ or CH. ▲** to select TV channels.
- 4 Press MENU** to see the TV's on-screen menu. In the menu, use VOL. ▼/▲ and CH. ▼/▲ buttons to make adjustments or selections.
You can press MENU on either the remote control or the front of the TV to access or remove the menu.

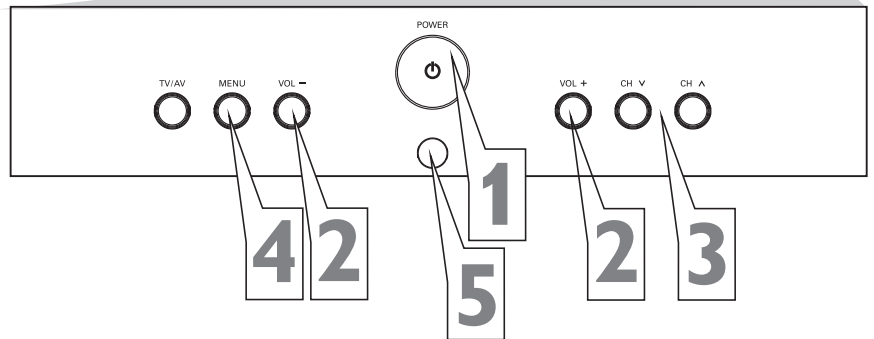
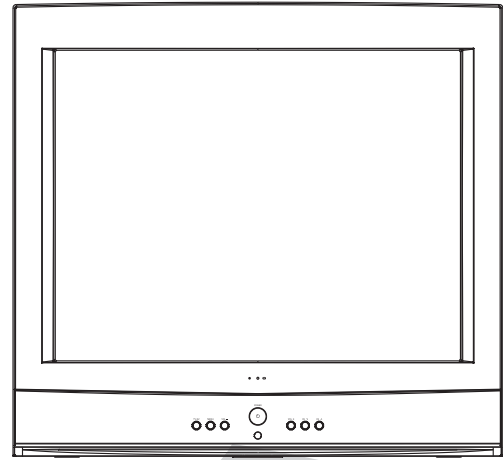

Remote control

- 5 Point the remote control** toward the remote sensor on the front of the TV when operating the TV with the remote control.

Battery Installation

To load batteries into the remote control:

- 1 Remove the battery compartment lid** on the rear of the remote. Press in the tab, then lift off the lid.
- 2 Place two AA batteries in the remote.** Be sure the (+) and (-) ends of the batteries line up correctly (as marked inside the battery compartment).
- 3 Reattach the battery compartment lid.**

Battery Installation

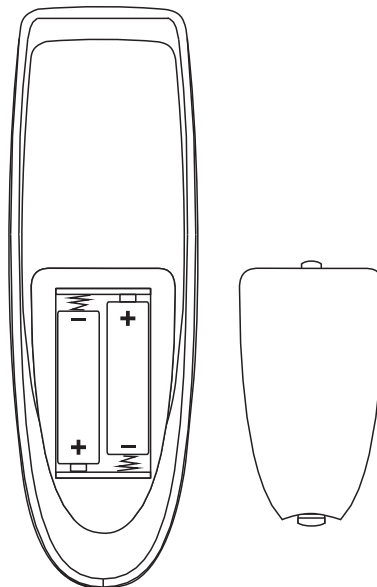

Helpful Hints

The channel number will appear briefly when you change channels. Or, press DISPLAY on the remote to see the channel number.

Press TV/AV on the front of the TV to choose AV1/AV2, or CVI.

Remote Control



TV/AV Button

Press to select TV channels or the Audio /Video IN channels (AV1, AV2, or CVI).

A/CH Button

In TV mode, press to return to the previous channel.

Note: In AV mode, press A/CH to only enter TV mode.

DISPLAY

Press to see the current channel number on the TV screen. Press again to display the current time on the screen.

Press to remove a menu from the screen. Sleep timer countdown can be displayed too when display key is toggled.

SLEEP Button

Press to select a time period (15 minutes to 180 minutes) after which the TV will turn itself off. Details are on page 22.

MTS Button

Press to select a sound mode if available with the TV programming: MONO, STEREO, SAP . Details are on page 31.

MENU Button

Press to see the TV's on-screen menu. Press to go back to the previous menu or to remove a menu from the screen.

FAVORITE Button

Press to browse the channels preset in Favorite List. Details are on page 14.

SMART PICTURE Button

Press to select one of the four picture settings (Personal, Movies, Sports, Weak Signal). Details are on page 17.

VOL(ume) +/- Button

Press to adjust the TV sound level.

STANDBY (POWER) Button

Press to turn the TV on or off (standby). You also can turn on the TV by pressing the CH(annel) ▼/▲ buttons on the front of the TV.

NUMBER Buttons

Press to select TV channels directly. For single-digit channels, press two "0" first, then the number of the channel.

For double-digit channels, press first digit then follow by another number of the channel. For example, to choose channel 45, press number 4 then follow by number 5.

For channels 100 and above, press three number buttons of the channel directly. (You can select channels above 69 only if you have Cable TV. Make sure TV/CATV is set to CATV. Details are on page 11.)

MUTE Button

Press to cancel or restore the TV sound. Pressing the volume buttons (VOL ▲ or VOL +) also will cancel mute and restore the sound.

OK Button

Within on-screen menu, press to enter some special function, such as Favorite List, etc..

SMART SOUND Button

Press to select one of the four sound settings (Voice, Music, Theatre, or Personal). Details are on page 29.

CH(annel) +/- Button

Press to select memorized TV channels.

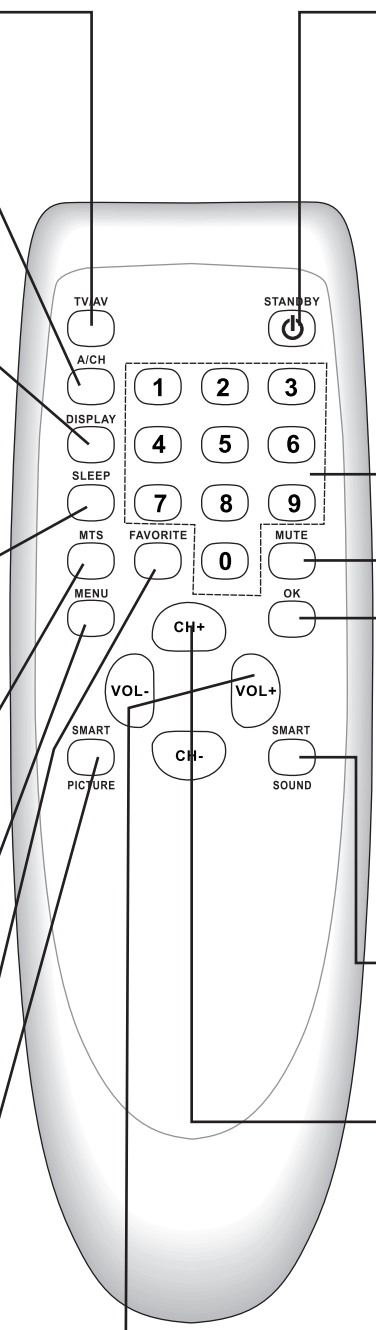



Language

You can set the TV's on-screen menu to English, French or Spanish.

- 1** Press **MENU** to see the menu.
- 2** Press **VOL+** or **VOL-** to highlight  (Feature).
- 3** Press **CH-** to highlight **Language**.
- 4** Press **VOL+** or **VOL-** to select **English**, **French** or **Espanol** (Spanish).
- 5** Press **MENU** repeatedly to remove the menu from the screen or the menu will automatically disappear within a few seconds if no buttons are pressed on the remote control.

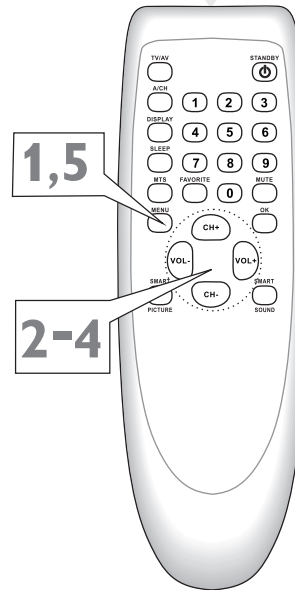
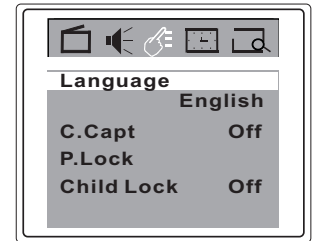
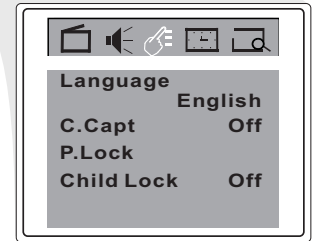
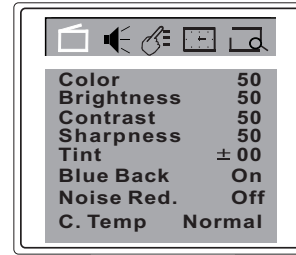

Helpful Hints

The language control only affects the language of the TV menus. It does not change the other on-screen text features, such as Closed Captions.

TV/Cable TV(CATV)



It is important for the TV to know what type of signal-Cable TV (CATV) or a normal antenna-you are using. To tell the TV whether you are using a cable TV signal, set TV/CATV to TV or CATV as follows.

- 1 Press MENU** to see the menu.
- 2 Press VOL+ or VOL-** to highlight  (Preset).
- 3 Press CH-** to enter **Preset** submenu. **TV/CATV** is highlighted.
- 4 Press VOL+ or VOL-** to select **TV** or **CATV**.
Choose CATV if you have Cable TV service. (See page five for connection details.) If you do not have Cable TV service and you connected an antenna to the TV, choose TV. (See page six for connection details.)
- 5 Press MENU repeatedly** to remove the menu from the screen or the menu will automatically disappear within a few seconds if no buttons are pressed on the remote control.

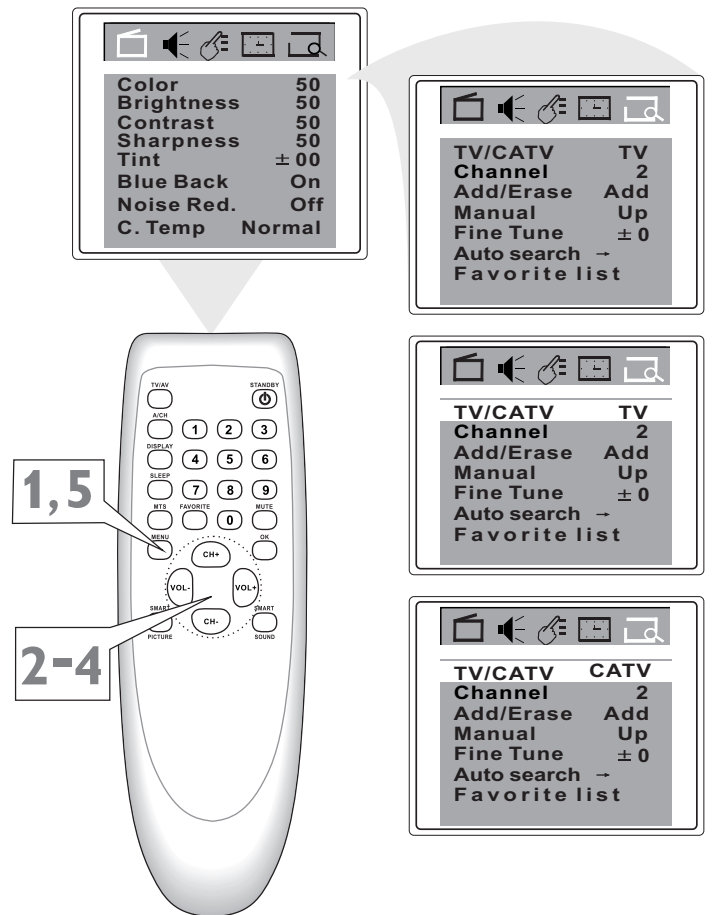

Helpful Hints

When CATV is selected, channels 1-125 are available.

When TV is selected, only channels 2-69 are available.

You cannot select Preset if the TV is set to Av1, AV2, or CVI. Press TV/AV repeatedly to get to the TV channels.



Auto Search (Setting TV Channels)

You can set your TV to receive local TV channels (From an antenna) or Cable TV channels (when you have Cable TV service). Use Auto search to set up channels that are available for you. This makes it easy for you to select only the available TV stations when you press CH+ or CH-. Before you start auto search, connect the Antenna or Cable TV signal as detailed on pages 5 and 6; set TV/CATV as described on page 11.

- 1** Press **MENU** to see the menu.
- 2** Press **VOL+** or **VOL-** to highlight  (**Preset**).
- 3** Press **CH-** to enter **Preset** submenu.
- 4** Press **CH+** or **CH-** repeatedly to highlight **Auto search**.
- 5** Press **VOL+** to start programming TV channels. Press the **VOL-** if you need to stop channel programming during the process.
When channel setup is completed, the TV will go to its lowest channel.

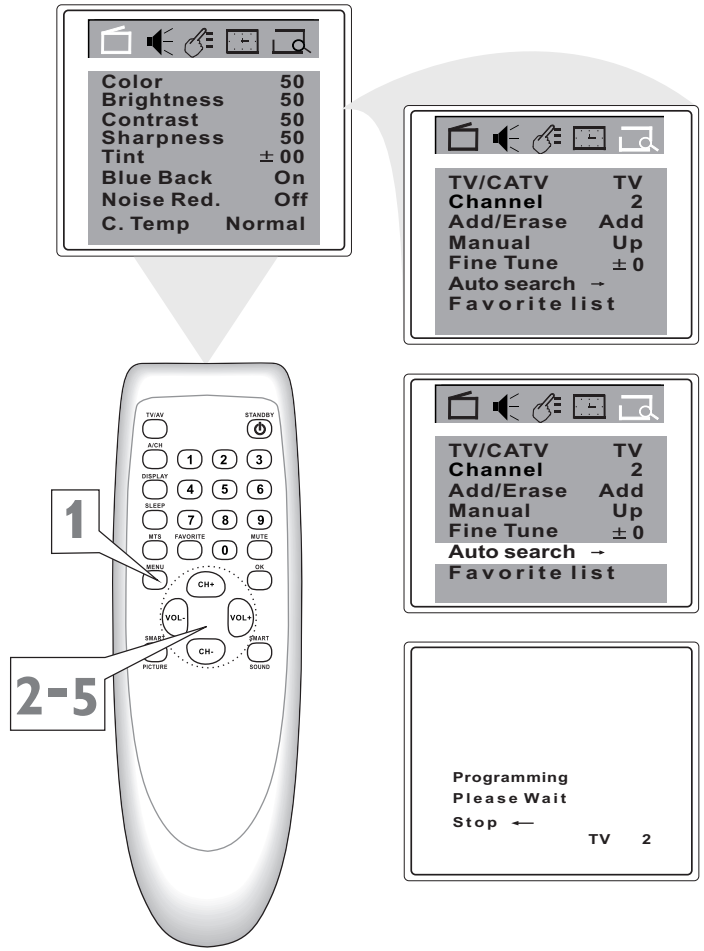

Helpful Hints

Press CH+ or CH- to see which channels are in the TV's memory. You can still select non-memorized channels using the Number buttons on the remote control.

To delete unwanted channels from the TV's memory or to add more channels, see ADD/ERASE on page 15.

You cannot select **Preset menu** if the TV is set to AV1, AV2, or CVI. Press TV/AV repeatedly to get to the TV channels.

Manual Channel Tuning



Manual Channel Tuning lets you quickly select the next available channel. For example, if you are looking for a channel between 60 and 70, start the search at channel 60 and go up.

- 1** Press **MENU** to see the menu.
- 2** Press **VOL+** or **VOL-** to highlight **TV** (Preset).
- 3** Press **CH-** to enter **Preset** submenu.
- 4** Press **CH+** or **CH-** repeatedly to highlight **TV/CATV**.
- 5** Press **VOL+** or **VOL-** to select TV or CATV (whichever you have). Details are on page 11.
- 6** Press **CH+** or **CH-** repeatedly to highlight **Channel**.
- 7** Press **VOL+** or **VOL-** to enter the channel number at which you want to begin the search.
- 8** Press **CH+** or **CH-** repeatedly to highlight **Manual**.
- 9** Press **VOL+** to start searching upward (for example, starting at channel 60 and going up to 61, 62, 63, etc.). Press **VOL-** when you find the channel you want. This stops the search. Otherwise the search will stop at the first available channel.

Or, press **VOL-** to start searching downward (for example, starting at channel 60 and going down to 59, 58, 57, etc.). Press **VOL+** when you find the channel you want. This stops the search. Otherwise the search will stop at the first available channel.

- 10** Press **MENU** repeatedly to remove the menu from the screen or the menu will automatically disappear within a few seconds if no buttons are pressed on the remote control.

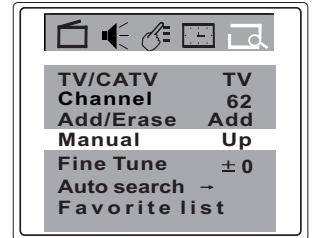
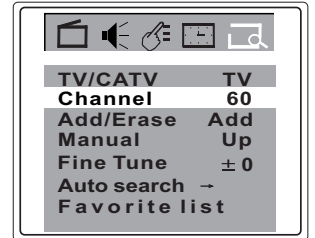
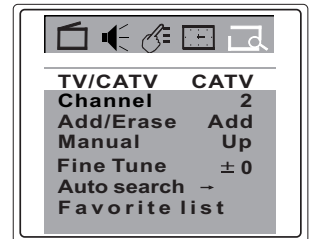
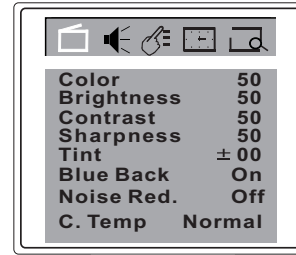

or

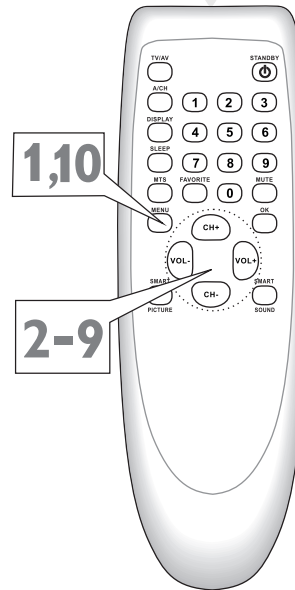
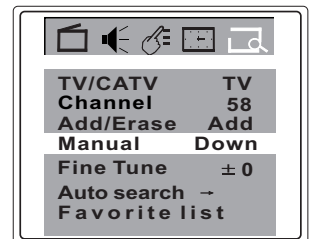

Helpful Hints

You cannot select **Preset** if the TV is set to AV1, AV2, or CVI. Press TV/AV repeatedly to get to the TV channels.



Favorite Channel Setting

You can store five channels you prefer into the Favorite list and recall these channels easily by press the FAVORITE button on the remote control.

- 1 Press **MENU** to see the menu.
- 2 Press **VOL+** or **VOL-** to highlight (Preset).
- 3 Press **CH-** to enter **Preset** submenu.
- 4 Press **CH+** or **CH-** repeatedly to highlight **Favorite list**.
- 5 Press **OK** to display features of **Favorite list**.
- 6 **TV/CATV** is highlighted. Press **VOL+** or **VOL-** to select TV or CATV (whichever you have).
- 7 Press **CH+** or **CH-** to select Ch3 (or Ch1, Ch2, Ch4, Ch5), then Press **VOL+** or **VOL-** to enter a channel number you want to store at this position, such as CATV 8.
- 8 Press **MENU** repeatedly to remove the menu from the screen or the menu will automatically disappear within a few seconds if no buttons are pressed on the remote control.

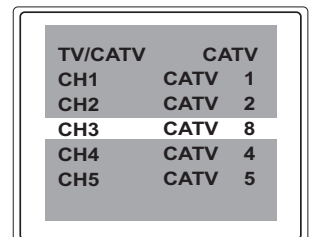
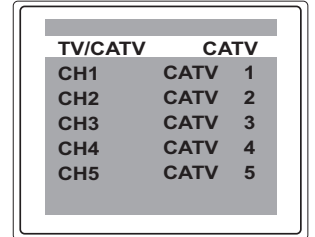
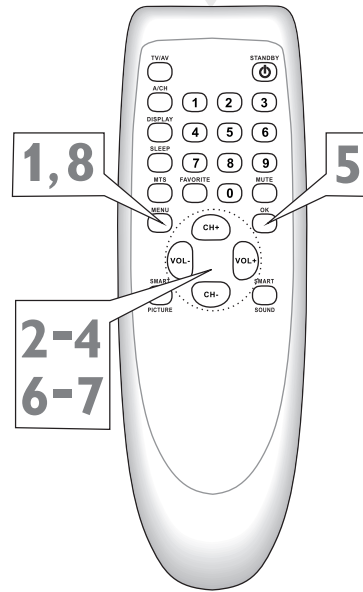
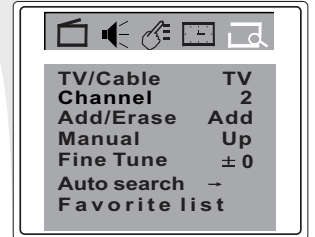
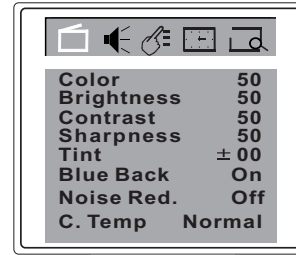

Helpful Hints

You cannot select **Preset** if the TV is set to Av1, AV2, or CVI. Press TV/AV repeatedly to get to the TV channels.

Adding or Erasing Channels



You can add or erase channels from the list in the TV's memory.

- 1** Using the **Number buttons**, select the channel you wish to add or erase.
- 2** Press **MENU** to see the menu.
- 3** Press **VOL+** or **VOL-** to highlight  (**Preset**).
- 4** Press **CH-** to enter **Preset** submenu.
- 5** Press **CH+** or **CH-** repeatedly to highlight **Add/Erase**.
- 6** Press **VOL+** or **VOL-** to choose **Add or Erase**.
If you select **Add**, the channel will be available when you press **CH+** and **CH-** to move through channels. Choosing **Erase** will remove the channel from the TV's memory. The channel will not be available when you flip through channels with the **CH+** and **CH-** buttons.
- 7** Press **MENU** repeatedly to remove the menu from the screen or the menu will automatically disappear within a few seconds if no buttons are pressed on the remote control.

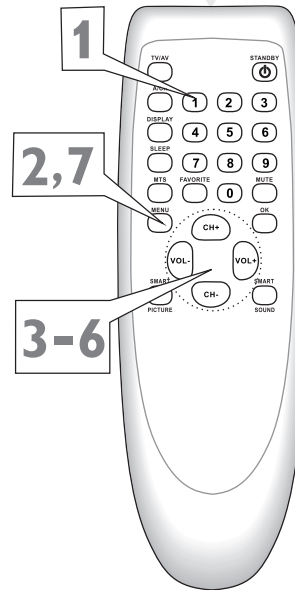

Color	50			
Brightness	50			
Contrast	50			
Sharpness	50			
Tint	±00			
Blue Back	On			
Noise Red.	Off			
C. Temp	Normal			

TV/CATV	TV			
Channel	12			
Add/Erase	Add			
Manual	Up			
Fine Tune	±0			
Auto search	-			
Favorite list				

TV/CATV	TV			
Channel	12			
Add/Erase	Add			
Manual	Up			
Fine Tune	±0			
Auto search	-			
Favorite list				

or

TV/CATV	TV			
Channel	12			
Add/Erase	Erase			
Manual	Up			
Fine Tune	±0			
Auto search	-			
Favorite list				

Helpful Hints

You cannot select **Preset** if the TV is set to AV1, AV2, or CVI. Press TV/AV repeatedly to get to the TV channels.



Picture Adjustment

To adjust your TV picture, select a channel and follow the steps below:

- 1 Press MENU** to see the menu.
- 2 Press CH-** to enter (Picture) submenu.
- 3 Press CH+ or CH-** repeatedly to highlight your choice: Color, Brightness, Contrast, Sharpness, Tint, Blue Back (background), Noise Red.(Noise Reduction), or C.Temp (color temperature.)
- 4 Press VOL+ or VOL-** to increase or decrease the element you choose. However, you can turn Blue Back to only On or Off (see below). You can choose Warm, Cool or Normal mode for color temperature.
- 5 Press MENU repeatedly** to remove the menu from the screen or the menu will automatically disappear within a few seconds if no buttons are pressed on the remote control.

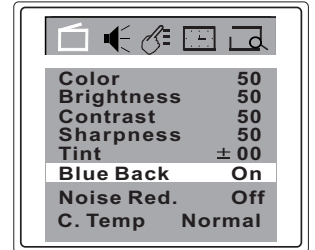
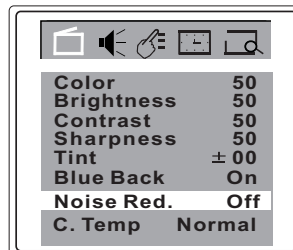
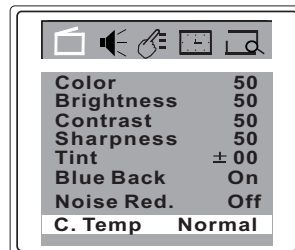
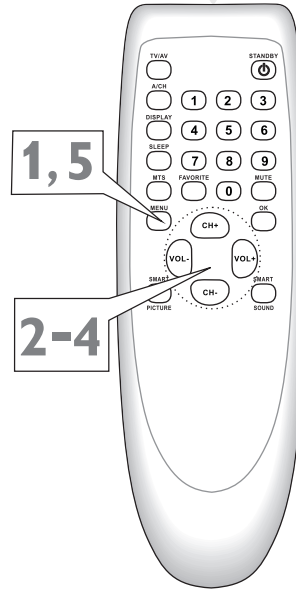
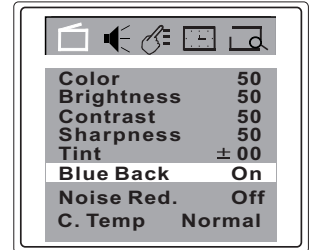
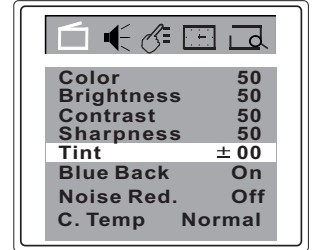
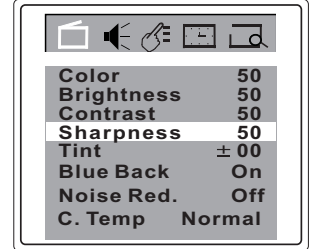
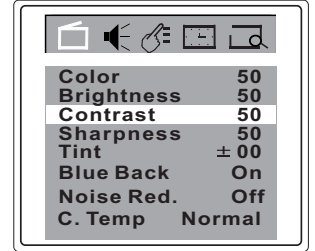
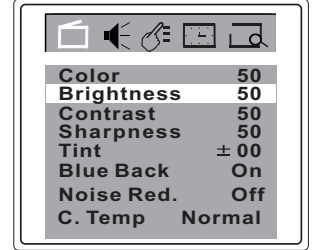
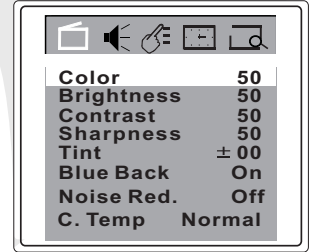
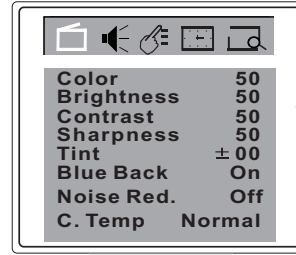

Helpful Hints

- Color** Add or reduce color.
- Brightness** Brighten the darkest parts of the picture.
- Contrast** Adjust the distinction between the black and white parts of the picture.
- Sharpness** Improve picture detail.
- Tint** Obtain natural skin tones.
- Blue Back** Turn this option ON or OFF. If you choose ON, a solid blue background screen will appear if the TV is on a weak channel(for example, if the reception is very poor or if the station has gone off the air for the night). After being on such a channel for 15 minutes, the TV will turn itself off automatically.
- Noise Red.** Turn this option ON or OFF. If you choose ON, it will reduce the video noise.
- C. Temp** Set this option to Normal, Warm or Cool mode.

Smart Picture



SmartPicture presets your TV's video settings for different types of programs and viewing conditions. Each SmartPicture setting is preset at the factory to automatically adjust the TV's Brightness, Color, Contrast, Sharpness.

- 1 Press SMART PICTURE** on the remote control. The current SmartPicture setting will appear on the screen.
- 2 Press SMART PICTURE repeatedly** to select Personal, Movies, Sports, or Weak Signal.
The Personal setting is what you specify with the picture adjustments as described on page 16. Personal is the only Smart Picture setting you can change. All others are set at the factory during production.

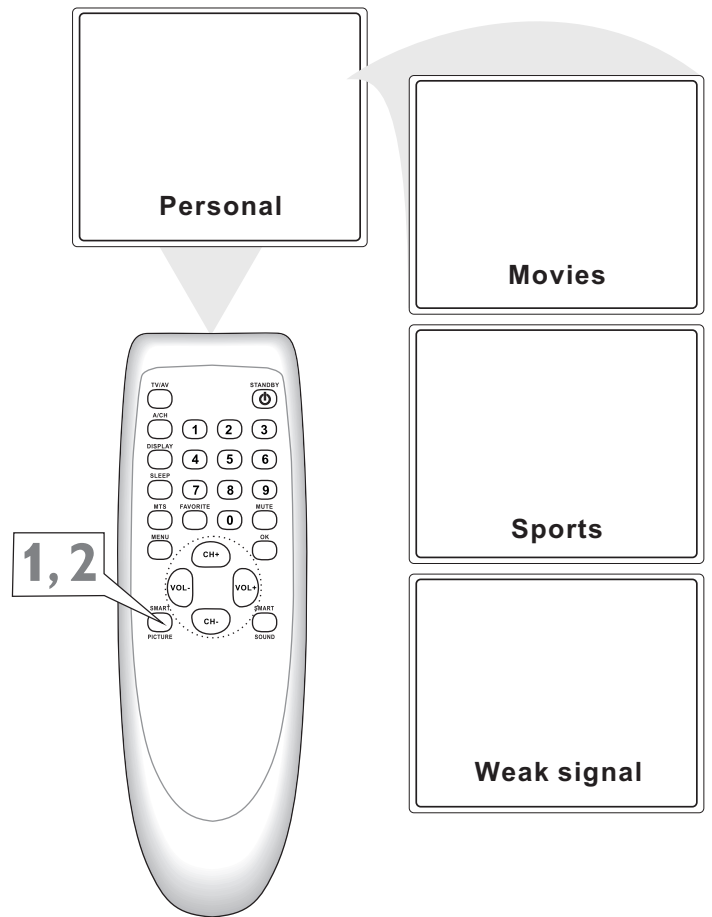



Clock

Follow these steps to set your TV's clock.

- 1** Press **MENU** to see the menu.
- 2** Press **VOL+** or **VOL-** to highlight  (Timer).
- 3** Press **CH-** to enter **Timer** submenu.
- 4** Press **CH+** or **CH-** repeatedly to highlight **Clock**.
- 5** Press **VOL+** or **VOL-** to enter the current time. Press and hold the **VOL+** or **VOL-** to change the time quickly in 10 minute increments.
- 6** Press **MENU** repeatedly to remove the menu from the screen or the menu will automatically disappear within a few seconds if no buttons are pressed on the remote control.

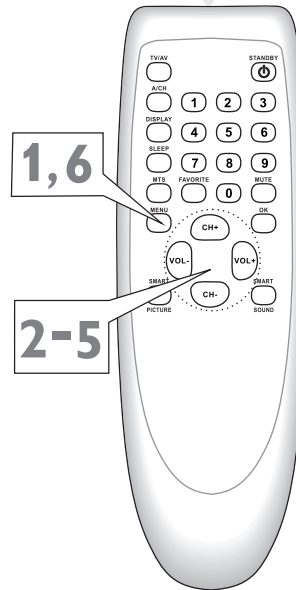
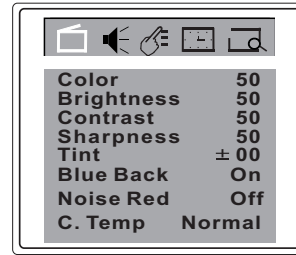

Helpful Hints

If the power fails, you must reset the clock.

On-Timer



To turn on the TV to a specific channel at a specific time, use the On-Timer. Before you begin, set the clock correctly. Details are on page 18.

- 1 Press MENU** to see the menu.
- 2 Press VOL+ or VOL-** to highlight (Timer).
- 3 Press CH-** to enter **Timer** submenu.
- 4 Press CH+ or CH-** repeatedly to highlight **Channel**.
- 5 Press VOL+ or VOL-** to enter the channel number. This will be the channel to which the TV turns on at the specified time.
- 6 Press CH+ or CH-** repeatedly to highlight **TV/CATV**.
- 7 Press VOL+ or VOL-** to select TV or CATV, depending on whether you have Cable TV service or not. Details are on page 11.
- 8 Press CH+ or CH-** repeatedly to highlight **On time**.
- 9 Press VOL+ or VOL-** to select **Once (or Daily, Off)**.
If you select Once, the timer will turn on the TV one time within the next 24 hours only.
If you select Daily, the timer will turn on the TV at the same time and to the same channel every day.
Choose Off to cancel the On-timer.
- 10 Press CH+ or CH-** repeatedly to highlight **0: 00** under the line of On Time.
- 11 Press VOL+ or VOL-** to enter the On time. Hold down VOL+ or VOL- to change the time quickly in 10-minute increments. This will be the time at which the TV will turn itself on.
- 12 Press MENU repeatedly** to remove the menu from the screen or the menu will automatically disappear within a few seconds if no buttons are pressed on the remote control.

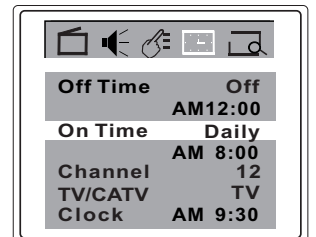
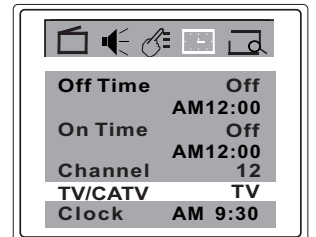
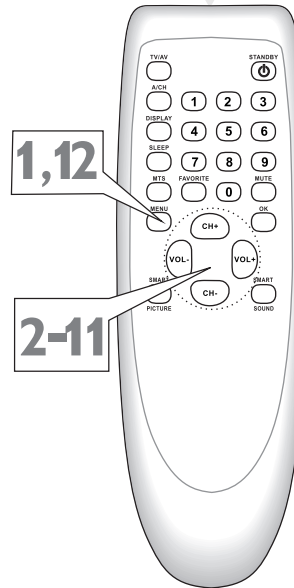
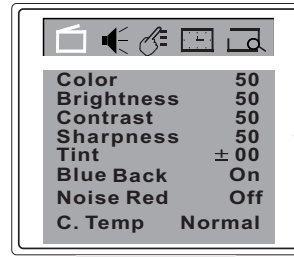



Off-Timer

To turn off the TV at a specific time every day, use the Off-Timer. Before you begin, you must set the clock correctly. Details are on page 18.

- 1 Press MENU** to see the menu.
- 2 Press VOL+ or VOL-** to highlight (Timer).
- 3 Press CH-** to enter Timer submenu.
- 4 Press CH+ or CH-** repeatedly to highlight **Off time**.
- 5 Press VOL+ or VOL-** to **Once (or Daily, Off)**.
If you select Once, the timer will turn off the TV once.
If you select Daily, the timer will turn off the TV at the same time every day.
Choose Off to cancel the Off-timer.
- 6 Press CH+ or CH-** repeatedly to highlight **0:00** under the line of Off Time.
- 7 Press VOL+ or VOL-** to enter the Off time. Hold down VOL+ or VOL- to change the time quickly in 10-minute increments. This will be the time at which the TV will turn itself off.
- 8 Press MENU repeatedly** to remove the menu from the screen or the menu will automatically disappear within a few seconds if no buttons are pressed on the remote control.

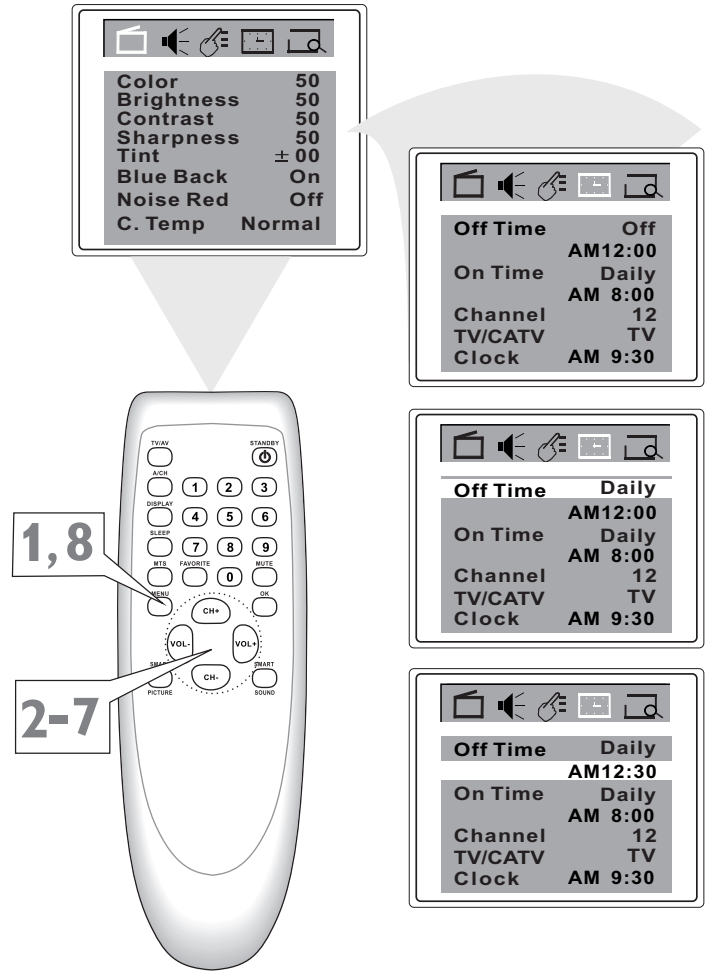

Closed Captions



Closed captioning (CC) lets you read the voice content of TV programs on the TV screen. Designed to help the hearing impaired, on-screen text boxes will show dialog, conversation, and activity during TV programming.

- 1 Press **MENU** to see the menu.
- 2 Press **VOL+ or VOL-** to highlight  (Feature).
- 3 Press **CH-** to enter Feature submenus.
- 4 Press **CH+ or CH-** to highlight **C.Capt.**
- 5 Press **VOL+ or VOL-** to select the closed caption you want (**Off, C1, C2, C3, C4 or C.Mute**). C.Mute sets the TV to show closed caption when you press MUTE. The TV volume will be disabled until you press MUTE or VOL+ again to restore the sound.
- 6 Press **MENU** repeatedly to remove the menu from the screen or the menu will automatically disappear within a few seconds if no buttons are pressed on the remote control.

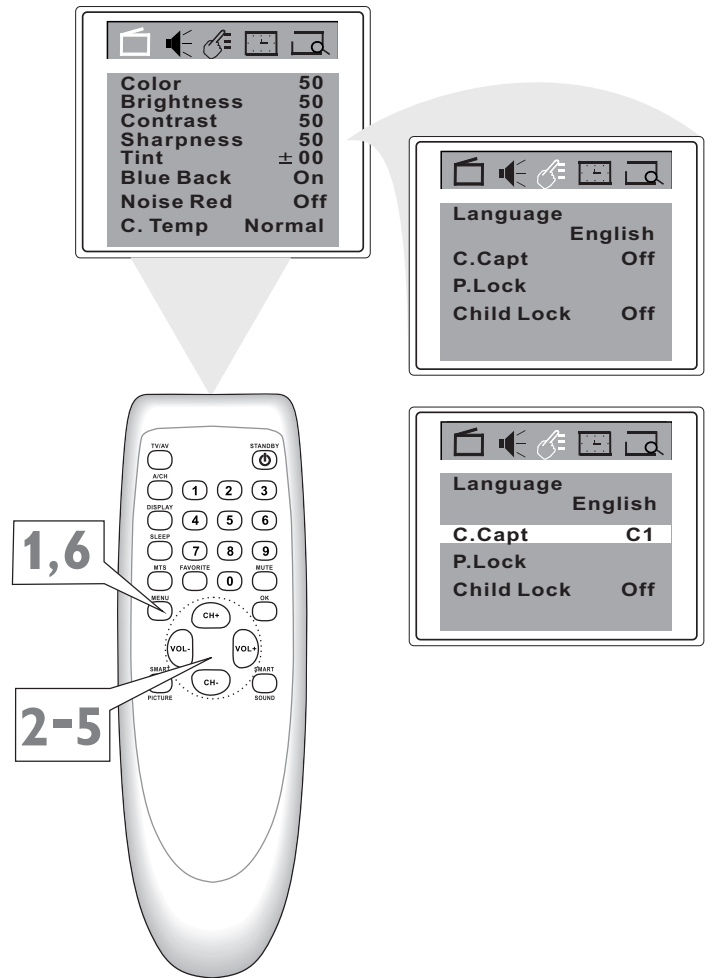

Helpful Hints

Not all TV programs and commercials are broadcast with Closed Caption information. Neither are all Closed Caption modes transmitted by a station for a closed caption program. See your TV listings for the stations and times of Closed Caption shows.



Sleep Timer

Have you ever fallen asleep in front of the TV, only to have it wake you up at two in the morning with a test pattern screeching in your ears? Well, your TV can save you that trouble by turning itself off.

- 1 Press SLEEP.** The sleep display will appear on the screen.
- 2 Within five seconds, press SLEEP** to pick the amount of time (in 15-minute increments) before the TV will turn itself off.

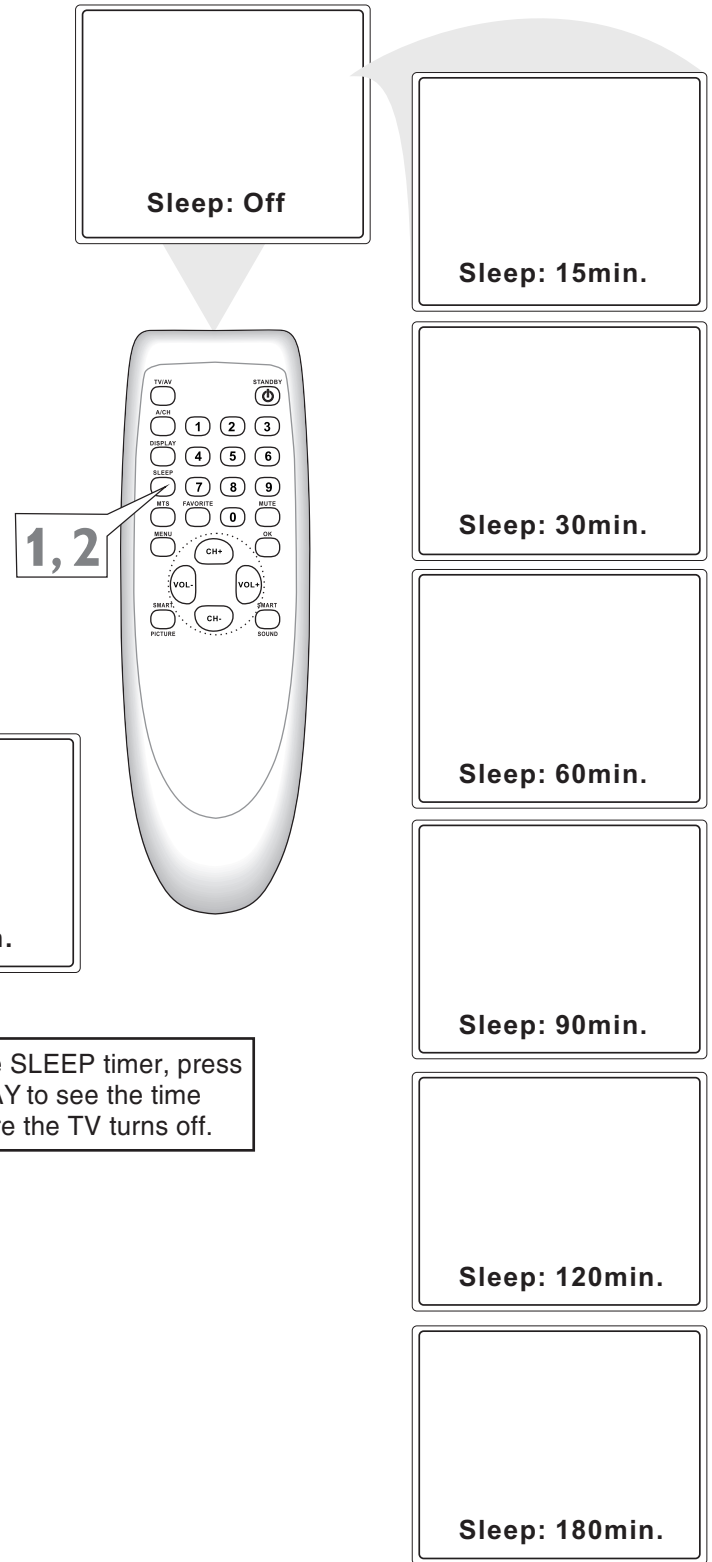

After setting the SLEEP timer, press SLEEP/DISPLAY to see the time remaining before the TV turns off.

Understanding Parental Lock



Parental Lock processes program content advisories from broadcasters. Parental Lock can respond to the content advisories and block objectionable content (offensively language, violence, sexual situations, etc.) This is a great feature to censor the type of programming children watch. **Parental Lock offers various blocking options from which to choose:**

MASTER ENABLE: this is the “master switch” for Parental Lock. When ON, all blocking/censoring you have set is enabled. When OFF, all blocking is disabled.

BLOCK UNRATED: All unrated programs (based on Movies Ratings or TV Ratings) will be blocked if this feature is ON and MASTER ENABLE is ON.

BLOCK NO RATING: All programming with no content advisory data will be blocked if this feature is ON and MASTER ENABLE is ON.

After you set a secret code, you can block up to six ratings in TV Ratings or Movie Ratings. These ratings are set by the Motion Pictures Association of America and TV broadcasters.

MPAA Ratings

(Motion Picture Association of America)

G: General Audience - All ages admitted. Most parents would find this program suitable for all ages. This type of programming contains little or no violence, no strong language, and little or no sexual dialog or situation.

PG: Parental Guidance Suggested - This programming contains material that parents may find unsuitable for younger children. It may contain one or more of the following: moderate violence, some sexual situations, infrequent coarse language, or some suggestive dialog.

PG-13: Parents Strongly Cautioned - This programming contains material that parents may find unsuitable for younger children under the age of 13. It contains one or more of the following: violence, sexual situations, coarse language, or suggestive dialog.

R: Restricted - This programming is specially designed for adult. Anyone under the age of 17 should only view the this programming with an accompanying parent or adult guardian. It contains one or more of the following: intense violence, intense sexual situations, strong coarse language, or intensely suggestive dialog.

NC17: No children under the age of 17 will be admitted - This type of programming should be viewed by adults only. It contains graphic violence, explicit sex, or crude, indecent language.

X: Adult only - This type of programming contains one or more of the following: very graphic violence, very graphic and explicit sexual acts, very coarse and intensely suggestive language.

TV Ratings

(TV broadcaster)

TV Y **TV-Y All children**-Appropriate for all children. - Designed for a very young audience, including children age 2-6. This type of programming is not expected to frighten younger children.

TV Y7 **TV-Y7 Directed to Older Children** - Designed for children age 7 and above. It may be appropriate for children who can distinguish between make-believe and reality. This programming may include mild fantasy and comic violence (FV or Fantasy violence).

TV G **TV-G General Audience** - Most parents would find this programming suitable for all ages - This type of programming contains little or no violence, no strong language, and little or no sexual dialog or situation.

TV PG **TV-PG Parents Guidance Cautioned** - Contains material that parents may find unsuitable for younger children. This type of programming contains one or more of the following: moderate violence(V), some sexual situations(S), infrequent coarse language (L), or some suggestive dialog (D).

TV 14 **TV-14 Parents Strongly Cautioned** - Contains material that parents may find unsuitable for children under 14 years of age. This type of programming contains one or more of the following: intense violence (V), intense sexual situations(S), strong coarse language (L), or intensely suggestive dialog (D).

TV MA **TV-MA Mature Audience only** - Specially designed to be viewed by adults and may be unsuitable for children under 17. This type of programming contains one or more of the following: graphic violence (V), explicit sexual situations(S), or crude, indecent language (L).



Parental Lock Secret Code

Over the next few pages, you will learn how to block programs and understand the rating terms for certain broadcasts. First, set a secret code.

- 1 Press MENU** to see the menu.
- 2 Press VOL+ or VOL-** to highlight (Feature).
- 3 Press CH-** to enter Feature submenus.
- 4 Press CH+ or CH-** to highlight **P.Lock**.
- 5 Press OK.** The display asking you to **Enter secret code** will appear on the screen.
If you want to set a new code, go on the steps 6-8 directly. (Or you can press the Number buttons to enter a four-digit code. The code "0000" is the default of the TV. If you have not set up a code previously, then "0000" is the code.)
- 6 Press VOL+ (on the remote) and the CH+ button on the front of the TV at the same time.** The display asking you to **Enter new code** will appear on the screen.
- 7 Press the Number buttons to enter a four-digit code.** The code will appear on the screen as you enter it.
- 8 Press OK to save the code.**
- 9 Press MENU repeatedly** to remove the menu from the screen or the menu will automatically disappear within a few seconds if no buttons are pressed on the remote control.

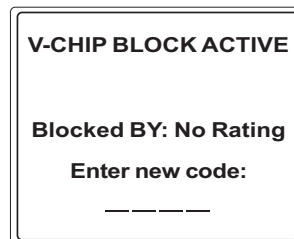
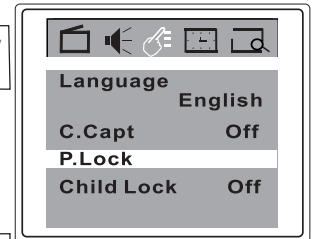
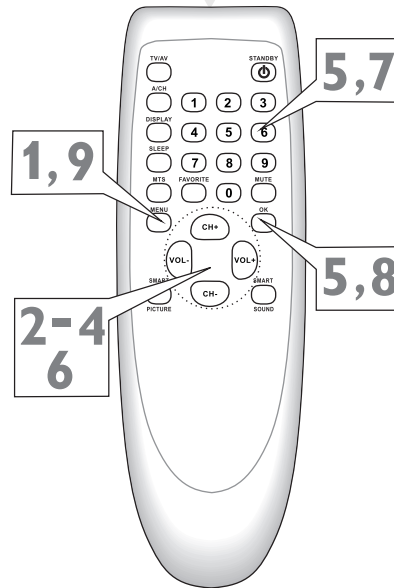
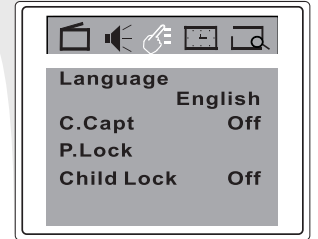
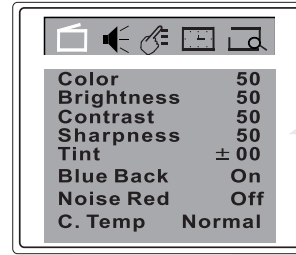

After V-CHIP BLOCK is active, user can enter directly enter the secrete code without going into the P.Lock menu.

Helpful Hints

You cannot change Parental Lock settings without knowing the secret code.

Blocking Programming with Movie Ratings



There are two types of ratings for P. Lock. One is based on movie industry ratings. The other is based on TV industry ratings. Both can be used to censor programming. Let's first look at the MPAA Rating options of P. Lock.

- 1 Press **MENU** to see the menu.
- 2 Press **VOL+ or VOL-** to highlight  (Feature).
- 3 Press **CH-** to enter Feature submenus.
- 4 Press **CH+ or CH-** to highlight **P.Lock**.
- 5 Press **OK** to display the secret code screen.
- 6 Press the **Number buttons** to enter your four-digit code. The P.Lock setup menu appears on the screen and the MPAA rating is highlighted.
- 7 Press **OK** to display MPAA ratings (G, PG, PG-13, R, NC-17, and X).
- 8 Press **CH+ or CH-** to select the rating you want to block.
- 9 Press **OK** to block (or unblock) the rating. A checkmark will appear to the left of the rating when blocked. When you block a rating, higher ratings are blocked automatically. To unblock all the ratings, select N/A.
- 10 Press **MENU** repeatedly to remove the menu from the screen or the menu will automatically disappear within a few seconds if no buttons are pressed on the remote control.

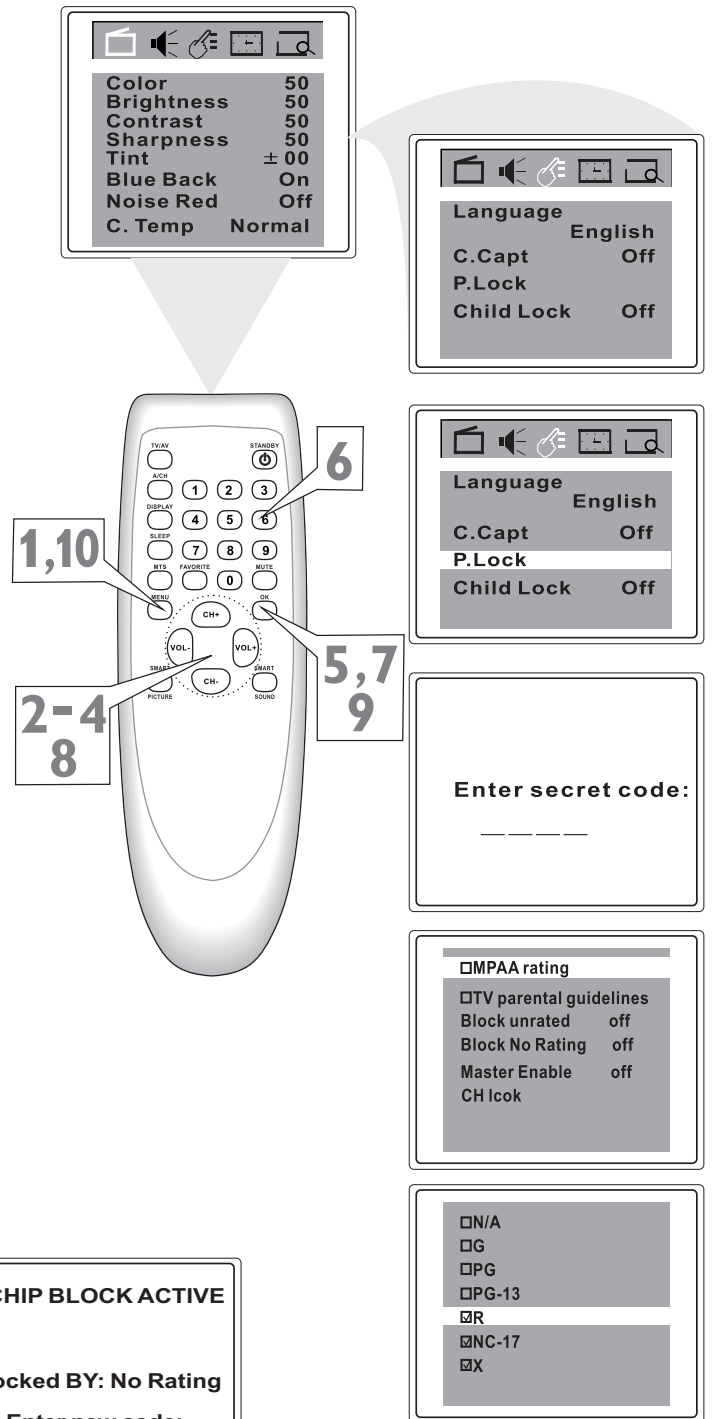

Helpful Hints

Blocking any rating (ON) will block all the higher ratings automatically. For example, if R is blocked manually, NC17 and X will be blocked automatically.

To turn a rating OFF, set each rating individually.

V-CHIP BLOCK ACTIVE

Blocked BY: No Rating

Enter new code: _____

After V-CHIP BLOCK is active, user can enter directly enter the secret code without going into the P.Lock menu.



Blocking Programming with TV Ratings

Some program ratings are based on TV industry ratings as described below.

- 1 Press **MENU** to see the menu.
- 2 Press **VOL+** or **VOL-** to highlight **Feature**.
- 3 Press **CH-** to enter Feature submenus.
- 4 Press **CH+** or **CH-** to highlight **P.Lock**.
- 5 Press **OK** to display the secret code screen.
- 6 Press the **Number buttons** to enter your four-digit code. The P.Lock setup menu appears on the screen.
- 7 Press **CH+** or **CH-** to highlight **TV parental guidelines**.
- 8 Press **OK** to display the parental guidelines (TV-Y, TV-Y7, TV-G, TV-PG, TV-14, or TV-MA).
- 9 Press **CH+** or **CH-** to select a rating.
- 10 Press **OK** to turn the rating on or off. A checkmark appears when the rating is blocked. TV-Y and TV-PG can be turned on (to block viewing) or off (to allow viewing) only. TV-Y7, TV-PG, TV-14, and TV-MA can be customized to block V (violence), F (fantasy), S (sexual situations), L (coarse language), or D (suggestive dialog). To do so, continue with these steps.
- 11 Press **CH+** or **CH-** to highlight **Content**.
- 12 Press **OK** button to enter the **Content** menu.
- 13 Press **CH+** or **CH-** to select a rating, then press **VOL+**.
- 14 Press **CH+** or **CH-** to select the sub-ratings (**Fantasy-V**, **Violence**, **Sexual**, **Language**, or **Dialog**), then press **OK** to block or view that sub-rating.
- 15 Press **MENU** to return to the Parental Guidelines screen and check your settings. A checkmark appears when the sub-rating is blocked.
- 16 Press **MENU** repeatedly to remove the menu from the screen or the menu will automatically disappear within a few seconds if no buttons are pressed on the remote control.

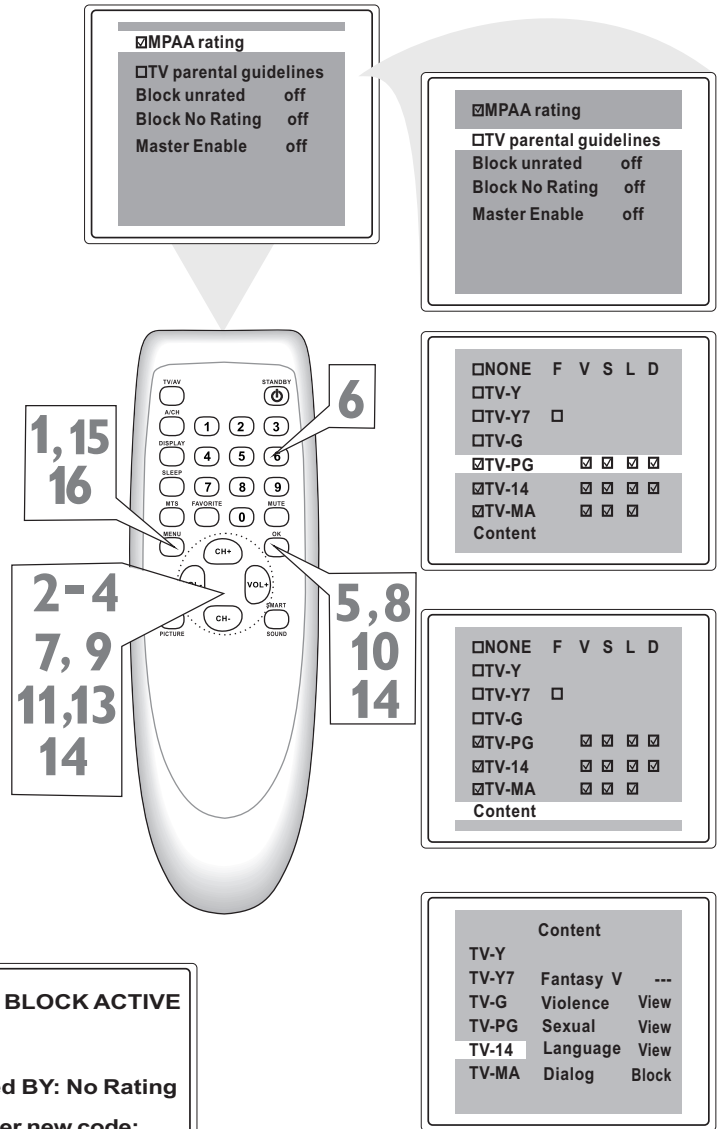

After V-CHIP BLOCK is active, user can enter directly enter the secrete code without going into the P.Lock menu.

Helpful Hints

Any rating will block higher ratings automatically. To unblock all the ratings, select NONE.

Notes:

1. Blocking TV-Y, only TV-Y7 is blocked automatically.
2. Blocking TV-Y7, other rating will not change any more.

Parental Lock Blocking Options



After setting your secret code, Parental Lock also offers these special blocking options.

- 1 Press **MENU** to see the menu.
- 2 Press **VOL+ or VOL-** to highlight **Feature**.
- 3 Press **CH-** to enter Feature submenus.
- 4 Press **CH+ or CH-** to highlight **P.Lock**.
- 5 Press **OK** to display the secret code screen.
- 6 Press the **Number buttons** to enter your four-digit code. The P.Lock setup menu appears on the screen.
- 7 Press **CH+ or CH-** to select **Master Enabled, Block Unrated, or Block No Rating**.
MASTER ENABLE: this is the “master switch” for Parental Lock. When ON, all blocking/censoring you have set is enabled. When OFF, all blocking is disabled.

BLOCK UNRATED: All unrated programs (based on Movies Ratings or TV Ratings) will be blocked if this feature is ON and MASTER ENABLE is ON.

BLOCK NO RATING: All programming with no content advisory data will be blocked if this feature is ON and MASTER ENABLE is ON.
- 8 Press **VOL+ or VOL-** to turn the blocking option **On or Off**.
- 9 Press **MENU** repeatedly to remove the menu from the screen or the menu will automatically disappear within a few seconds if no buttons are pressed on the remote control.

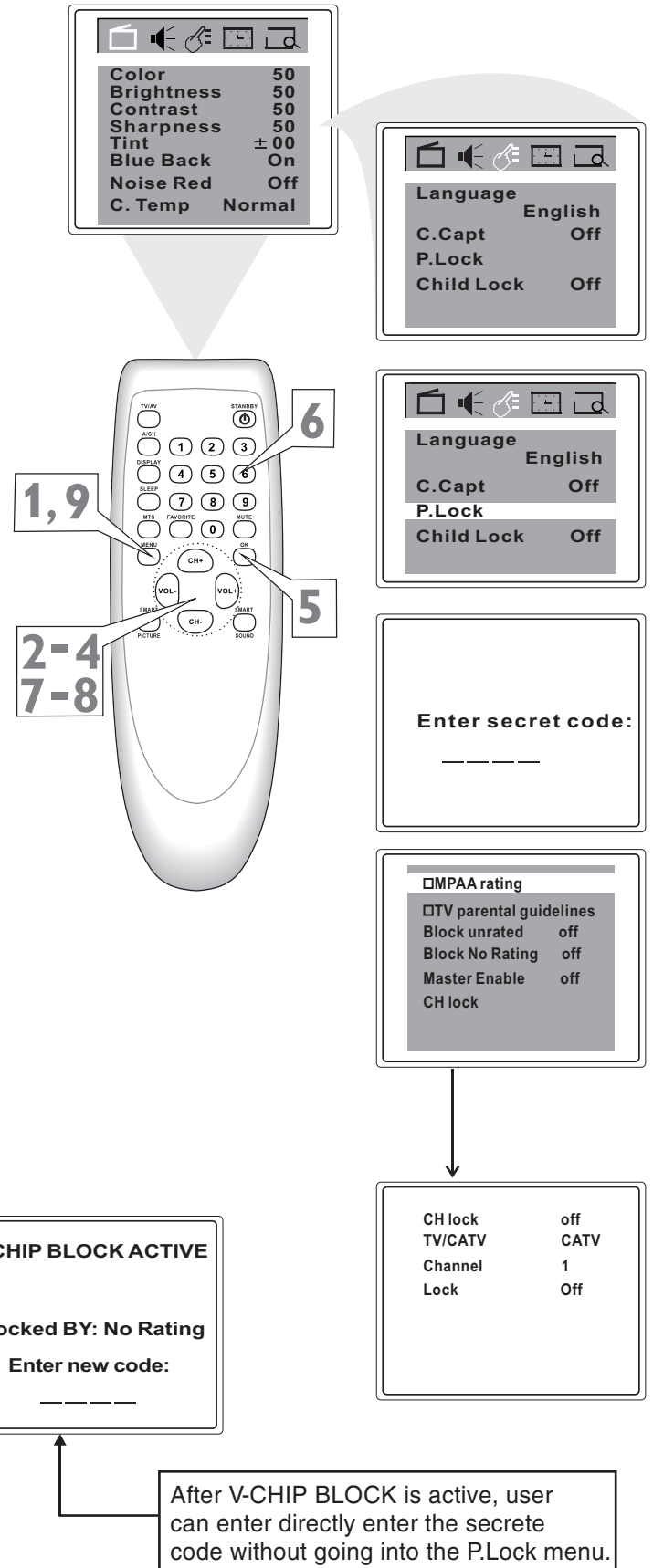

After V-CHIP BLOCK is active, user can enter directly enter the secrete code without going into the P.Lock menu.



Child Lock

Child Lock allows you to lock the buttons on the front of the TV.

- 1 Press MENU** to see the menu.
- 2 Press VOL+ or VOL-** to highlight  (Feature).
- 3 Press CH-** to enter Feature submenus.
- 4 Press CH+ or CH-** to highlight **Child Lock**.

Choose ON to disable all the buttons on the front of the TV. Child Lock On will appear on the TV screen each time when you press the button on the front of the TV.

You can still operate the TV with the remote control. You can still use the POWER button on the front of the TV, but only to turn off the TV (not on). Set Child Lock to Off to cancel this feature so you can use the buttons on the front of the TV again.

- 5 Press MENU repeatedly** to remove the menu from the screen or the menu will automatically disappear within a few seconds if no buttons are pressed on the remote control.

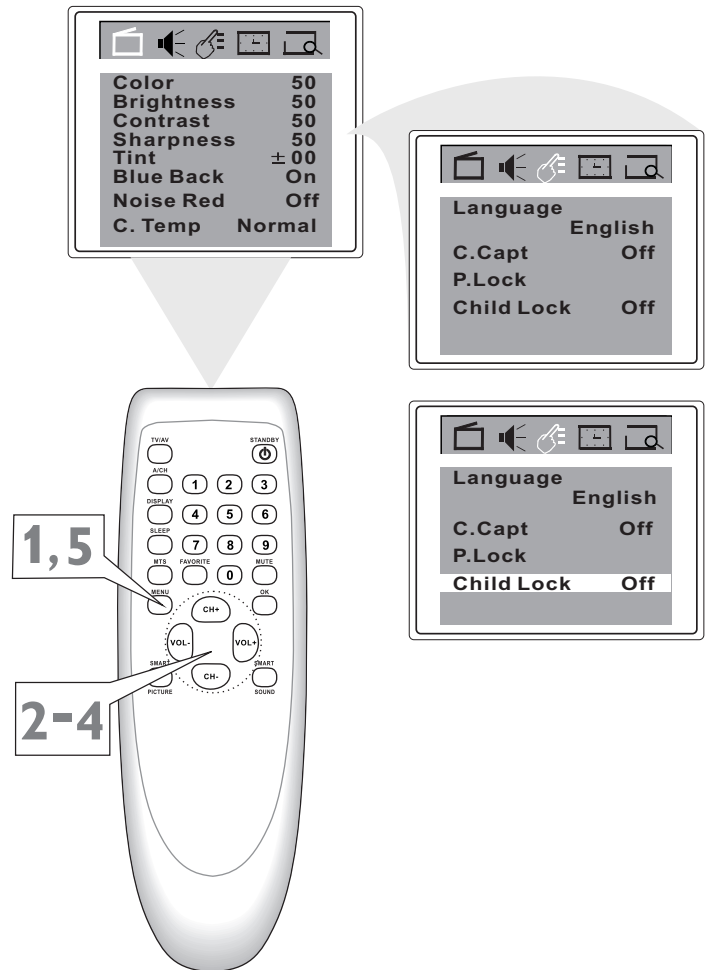



SmartSound offers you four preset sound options: Personal, Theatre, Music or Voice. Choose the one that best suits your current programming.

- 1** Press **MENU** to see the menu.
- 2** Press **VOL+** or **VOL-** to highlight **Sound**.
- 3** Press **CH-** to enter Sound submenus.
- 4** Press **CH+** or **CH-** to highlight **Smart Sound**.
- 5** Press **VOL+** or **VOL-** to select **Personal, Voice, Music, or Theatre**.
- 6** Press **MENU** repeatedly to remove the menu from the screen or the menu will automatically disappear within a few seconds if no buttons are pressed on the remote control.

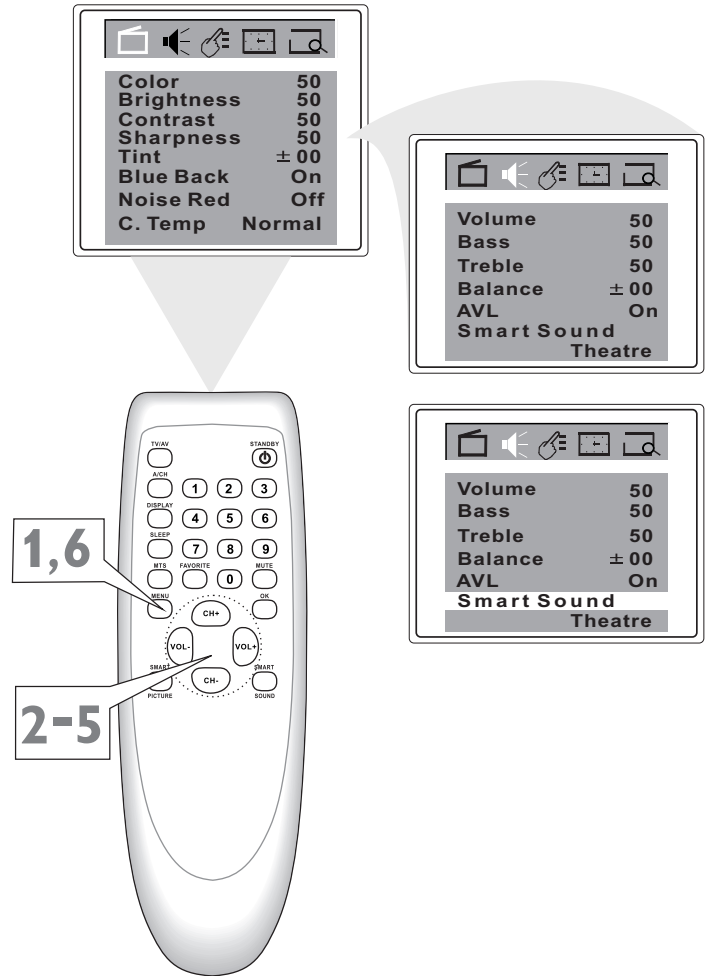

Helpful Hints

You can choose a Smart Sound setting quickly by pressing the **SMART SOUND** button on the remote control.



Sound Adjustments

You can adjust the low frequency (Bass) or high frequency (Treble). You can also adjust the Balance to increase the volume of the left and right sound channels.

- 1 Press **MENU** to see the menu.
- 2 Press **VOL+** or **VOL-** to highlight **Sound**.
- 3 Press **CH-** to enter Sound submenus.
- 4 Press **CH+** or **CH-** to highlight **Bass** (**Volume, Treble, Balance** or **AVL**).
- 5 Press **VOL+** or **VOL-** to adjust the option.
- 6 Press **MENU** repeatedly to remove the menu from the screen or the menu will automatically disappear within a few seconds if no buttons are pressed on the remote control.

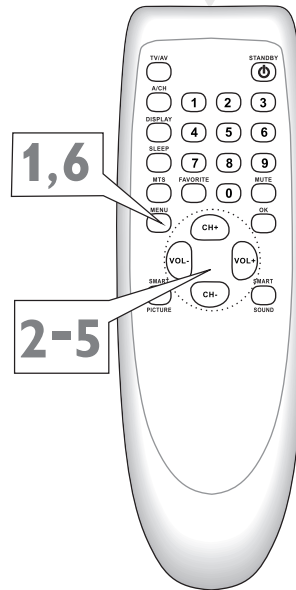
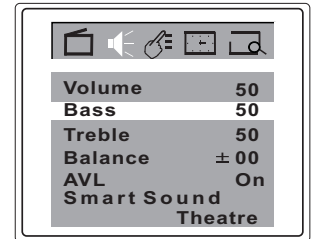
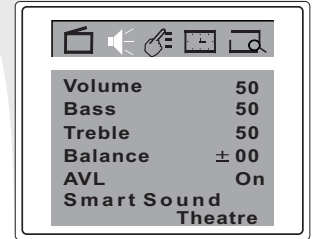
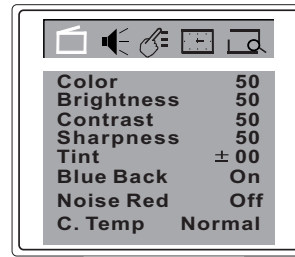

Helpful Hints

Bass: Enhances the low frequency sounds.
Treble: Enhances the high frequency sounds.
Balance: Distributes the sound between the left and right speakers of the TV.
AVL: Turn AVL on or off. When On, AVL will level out the sound being heard when sudden changes in volume occur during commercial breaks or channel changes.

Stereo and Second Audio Program



Multi-channel Sound (MTS) broadcasts enhance TV viewing by bringing you programs with high fidelity stereo sound.

MTS also provides an extra channel called the Second Audio Program (SAP), which broadcasters can use to transmit a second language or for other purposes.

- 1 Press MTS** on the remote control to select **STEREO, MONO, SAP**. All the options will be available only when the current TV channel is broadcasting that option. Channels will not always carry programs that have all the MTS options.

If **STEREO** appears on the screen when you select a channel, stereo broadcasting is available with the current TV program. You can hear sound from the left and right speakers of the TV.

If the broadcast is not strong or clear, stereo sound is not available. Press the MTS button to change to **MONO**. This should eliminate the noise.

If **MONO** appears on the screen when you choose a channel, Stereo is not available.

If **SAP** appears when you select a channel, Second Audio Program broadcasting is available for the current TV program. Press the MTS button to choose **SAP** and you may hear the program in a different language or some other audio.

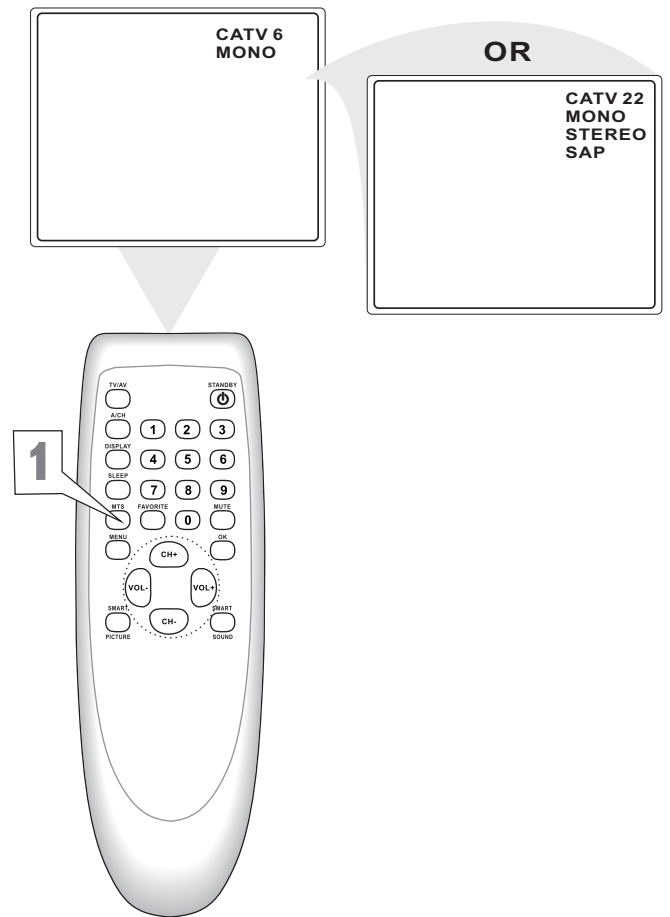



Helpful Hints

No Power

- Check the TV power cord. Disconnect the power cord from the power outlet for 10 seconds, then reinsert the plug into the outlet. Press the STANDBY button to turn on the TV again.
- Make sure the outlet is not on a wall switch.
- Make sure a fuse has not blown at the power outlet.

No Picture

- Check the antenna or Cable TV connections. Connect the antenna or Cable TV signal securely to the TV's 75 OHM ANTENNA INPUT jack on the rear of the TV.
- Set TV/CATV correctly. Details are on page 11.
- Activate AUTO SEARCH to find all available channels. Details are on page 12.
- Press TV/AV on the remote control to select TV channels or a video source (AV1/S-VIDEO, AV2, or YUV). Use AV1 /S-VIDEO, AV2, or YUV to view material on other equipment (Camcorder, VCR, DVD Player, etc.) that is connected to the TV's Audio and Video In jacks.

No Sound

- Press the VOL+ and VOL- buttons to adjust the volume.
- Press the MUTE button on the remote control to cancel or restore the volume.

Remote Control does not work.

- Check the batteries. If necessary, replace them with two AA heavy duty (zinc chloride) or alkaline batteries.
- Clean the remote control as well as the remote control sensor on the front of the TV.
- Check the TV power cord. Disconnect the power cord from the power outlet for 10 seconds, then reinsert the plug into the outlet. Press the STANDBY button to turn on the TV again.
- Make sure the outlet is not on a wall switch.
- Make sure a fuse has not blown at the power outlet.
- Always point the remote control toward the front of the TV (toward the remote sensor).

TV displays wrong channel or no channels.

- Repeat channel selection.
- Add the channel number(s) into the TV's memory. Use ADD/ERASE as described on page 15.
- Make sure TV/CATV is set correctly. Details are on page 11. Then activate AUTO SEARCH to set up all available channels. Details are on page 12.



Care and Cleaning

WARNING concerning stationary images on the TV screen: Do not leave fixed images on the screen for extended periods of time. This can cause uneven aging of the picture tube.

Normal use of the TV should involve viewing of programs that have constantly moving or changing images. Do not leave non-moving images on screen for extended periods of time. Do not display the same images too frequently; subtle "ghost" images can be left on the picture tube. Sources of stationary images may be Laser discs, video games, Compact Discs Interactive (CD-i), or paused Digital Video Discs (DVDs) or videotapes.

Here are some common examples of stationary images:

- **DVD menus** - listings of DVD content.
- **Letterbox black bars** - appear at the top and bottom of the TV screen when a wide screen (16:9) movie is viewed on a TV with standard (4:3) aspect ratio. This is available with some DVDs.
- **Video-game images and scoreboards**
- **Television station logos** - These cause a problem if they are bright and stationary. Moving or low-contrast graphics are less likely to damage the picture tube.
- **Stock-market tickers** - may appear at the bottom of the TV screen if the TV programming covers this news.
- **Shopping channel logos, pricing displays** - These may be bright and may appear constantly during the show. These are usually in the same location on the TV screen.

TV LOCATION

- To avoid cabinet warping, cabinet color changes, and an increased chance of TV failure, do not place the TV where temperatures can become excessively hot (for example, in direct sunlight or near a heating appliance).
- Allow a free flow of air around the TV.

CLEANING

- To avoid possible shock hazard, remove the TV's power cord from the electrical outlet before cleaning.
- Regularly dust the TV with a dry, non-scratching duster.
- When cleaning the TV, take care not to scratch or damage the screen surface. Avoid wearing jewelry or using anything abrasive. Do not use household cleaners. Wipe the screen with a clean cloth dampened with water. Use even, easy, vertical strokes when cleaning.
- Gently wipe the cabinet surfaces with a clean cloth or a sponge dampened in a solution of cool, clear water and a mild soap or detergent. Use a clean, dry cloth to dry the wiped surfaces.
- Occasionally vacuum the vents on the rear of the TV.
- Never use thinners, insecticide sprays, or other chemicals on or near the cabinet. They may blemish the cabinet permanently.

Glossary



Audio/Video Inputs • Jacks (standard RCA) on the rear of the TV to which you connect accessory devices. These jacks receive picture and sound from equipment such as a DVD Player, VCR, Camcorder, etc..

Auto Program • Scans all available channels from regular antenna or Cable TV signals and stores only active stations in the TV's memory.

Closed Captioning • The broadcast feature that lets you read the voice content of television programs on the TV screen. Designed to help the hearing impaired, Closed Captioning shows dialog, activity, and conversations while a TV program is in progress.

Coaxial Cable • A single solid wire normally matched with a metal plug (F-type) end connector that screws (or pushes) directly onto a 75-ohm input on the television or VCR.

Menu  An on-screen list of controls available for adjustment.

On-screen Displays (OSD) • Messages that help you set up features (color adjustment or channel programming, for example).

Remote Control Sensor • The window or opening on the front of the TV through which infrared remote control signals are received.

Index



Add/Erase Channels	15	On-Timer	19
Antenna Connection	6	Off-Timer	20
Audio jacks	7	Parental Lock	
Auto Search	12	Blocking Options	27
Sound Adjustments	30	Movie Ratings	25
Battery Installation	8	Secret Code	24
Blue Back (background)	16	TV Ratings	26
Brightness	16	Understanding Parental Lock	23
Cable TV Connection	5	Picture	16
Channel Setup	12	Picture Adjustments	16
Child Lock	28	Registration	2
Cleaning	32	Remote Control	8-9
Clock	18	S-Video	7
Closed Captions	21	Safety	3
Color	16	Second Audio Program (SAP)	31
Component Video Connections (DVD Player)	7	Sharpness	16
Contrast	16	Sleep Timer	22
DVD video in channel	7	SmartPicture	17
DVD (Y Cb Cr) video in jacks	7	SmartSound	29
Factory Service	34-35	Stereo	31
Glossary	33	Tint	16
Helpful Hints	32	TV/Cable TV	11
Language	10	Warranty	36
Manual Channel Tuning	13	Y Cb Cr (DVD) video in jacks	7
Mono	31		

MAGNAVOX LIMITED WARRANTY

Ninety (90) Days Labor & One (1) Year Parts & One (1) Year Display

MAGNAVOX warrants this product against defect in material or workmanship, subject to any conditions set forth as follows:

PROOF OF PURCHASE:

You must have proof of the date of purchase to receive warranted repair on the product. A sales receipt or other document showing the product and the date that you purchased the product as well as the authorized retailer included, is considered such proof.

COVERAGE:

(If this product is determined to be defective)

LABOR: For a period of ninety (90) days from the date of purchase, Magnavox will repair or replace the product, at its option, at no charge, or pay the labor charges to any Magnavox authorized service center. After the period of ninety (90) days, Magnavox will no longer be responsible for charges incurred.

PARTS: For a period of one (1) year, Magnavox will supply, at no charge, new or rebuilt replacement parts in exchange for defective parts. Magnavox authorized service centers will provide removal and installation of the parts under the specified labor warranty.

DISPLAY: For a period of one (1) year from the date of purchase, Magnavox will supply, at no charge, a new or rebuilt active display device in exchange for the defective display. Magnavox authorized service centers will provide removal and installation of the parts under the specified labor warranty. (PTV screens carry a thirty (30) day replacement warranty.)

EXCLUDED FROM WARRANTY COVERAGE

Your warranty does not cover:

- Labor charges for installation or setup of the product, adjustment of customer controls on the product, and installation or repair of antenna systems outside of the product.
- Product repair and/or part replacement because of improper installation, connections to improper voltage supply, abuse, neglect, misuse, accident, unauthorized repair or other cause not within the control of Magnavox.
- A product that requires modification or adaptation to enable it to operate in any country other than the country for which it was designed, manufactured, approved and/or authorized, or repair of products damaged by these modifications.
- Damage occurring to product during shipping when improperly packaged or cost of associated packaging.
- Product lost in shipment and no signature verification of receipt can be provided.
- A product used for commercial or institutional purposes (including but not limited to rental purposes).
- Products sold AS IS or RENEWED.

TO OBTAIN WARRANTY SERVICE IN THE U.S.A., PUERTO RICO, OR U.S. VIRGIN ISLANDS...

Contact Magnavox Customer Care Center at:
1-800-705-2000

TO OBTAIN WARRANTY SERVICE IN CANADA...

1-800-661-6162 (French Speaking)
1-800-705-2000 (English or Spanish Speaking)

REPAIR OR REPLACEMENT AS PROVIDED UNDER THIS WARRANTY IS THE EXCLUSIVE REMEDY FOR THE CONSUMER. MAGNAVOX SHALL NOT BE LIABLE FOR ANY INCIDENTAL OR CONSEQUENTIAL DAMAGES FOR BREACH OF ANY EXPRESS OR IMPLIED WARRANTY ON THIS PRODUCT. EXCEPT TO THE EXTENT PROHIBITED BY APPLICABLE LAW, ANY IMPLIED WARRANTY OF MERCHANTABILITY OR FITNESS FOR A PARTICULAR PURPOSE ON THIS PRODUCT IS LIMITED IN DURATION TO THE DURATION OF THIS WARRANTY.

Some states do not allow the exclusions or limitation of incidental or consequential damages, or allow limitations on how long an implied warranty lasts, so the above limitations or exclusions may not apply to you. In addition, if you enter into a service contract agreement with the MAGNAVOX partnership within ninety (90) days of the date of sale, the limitation on how long an implied warranty lasts does not apply.

This warranty gives you specific legal rights. You may have other rights which vary from state/province to state/province.

Magnavox, P.O. Box 671539, Marietta, GA. 30006-0026

(Warranty: 4835 710 28125)